

MW Order No. :DC PLUG-P1M-R7B

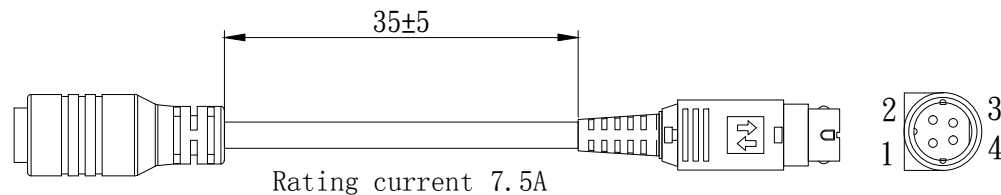

Pin Assignmet

P1M+ connected to R7B P1、4 (+)  
P1M- connected to R7B P2、3 (-)

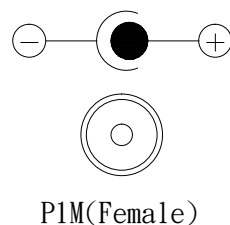
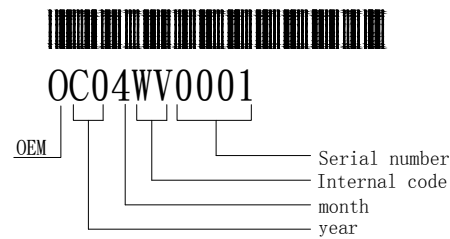



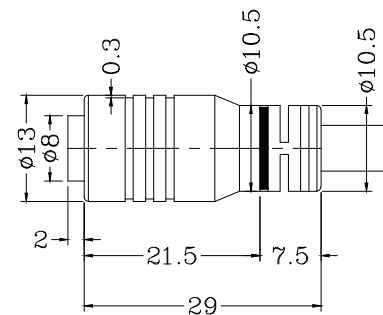

0:OEM  
C0:2020 (A:0, B:1, C:2)  
4:April(A:10, B:11, C:12)  
WV:Internal code  
0001:Serial number



Remark:  
1. 30pcs per packing

PACKAGING BAG

MW' s Order NO.	DC PLUG-P1M-R7B
Specification	Straight P1M (2.5*5.5*11mm) 4pin din R7B → (KYCON KPPX-4P equivalent)  R7B P1、4 (+) 2  R7B P2、3 (-) 1 
Quantity	1 pc
Bar code	 OC04WV0001



明緯企業股份有限公司  
MEAN WELL ENTERPRISES CO., LTD.

ITEM DC PLUG CONVERTER