



Features

- Wide input range 180 ~ 528VAC
- Constant power mode output
- Metal housing with Class I design
- Surge protection with 8KV/4KV
- Built-in active PFC function
- IP67 design for indoor or outdoor installations
- Function options: output adjustable via potentiometer; 3 in 1 dimming (dim-to-off) ; Smart timer dimming
- Auxiliary DC output optional
- Typical lifetime>50000 hours
- 5 years warranty

Applications

- Harbor lighting
- LED high-bay lighting
- Parking lot lighting
- LED fishing lamp
- Horticulture lighting
- Stadium lighting
- Type “HL” for use in Class I , Division 2 hazardous (Classified) location.

GTIN CODE

MW Search: <https://www.meanwell.com/serviceGTIN.aspx>

Description

HVGC-650 series is a 650W LED AC/DC driver featuring the constant power mode with wide output voltage range. HVGC-650 operates from 180~528VAC and offers models with different rated current ranging between 2800mA and 14000mA. Thanks to the high efficiency up to 95.5%, with the fanless design, all models are able to operate for -40°C~+85°C case temperature under free air convection. The design of metal housing and IP67 ingress protection level allows this series to fit both indoor and outdoor applications, such as horticulture lighting and stadium light HVGC-650 is equipped with various function options, such as dimming methodologies, so as to provide the optimal design flexibility for LED lighting system.

Model Encoding

HVGC - 650 **A** - **M** - **AB**

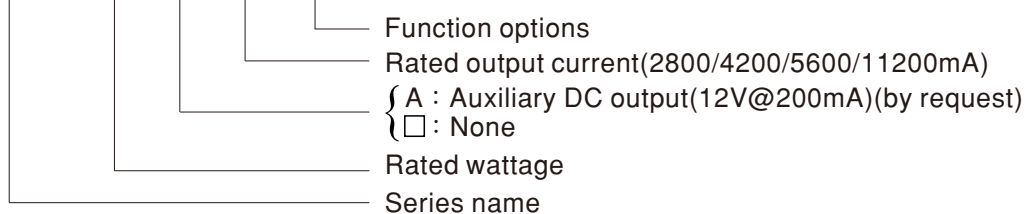

| Type | IP Level | Function | Note |
|------|----------|--|------------|
| AB | IP67 | Standard constant power output with 3 in 1 dimming function (0~10Vdc, 10V PWM signal and resistance) and built-in potentiometer. | In Stock |
| D2 | IP67 | Built-in Smart timer dimming and programmable function. | By request |
| Dx | IP67 | Built-in Smart timer dimming function by user request. | By request |
| DA | IP67 | DALI control technology with Io Adjustable via built-in potentiometer. | By request |



SPECIFICATION

| MODEL | HVGC-650□-L-□ | HVGC-650□-M-□ | HVGC-650□-H-□ | HVGC-650□-U-□ | |
|-----------------------------------|---|--|---------------|---------------|---------------|
| OUTPUT | RATED CURRENT | 2800mA | 4200mA | 5600mA | 11200mA |
| | RATED POWER | 649.6W | 651W | 649.6W | 649.6W |
| | CONSTANT CURRENT REGION <small>Note.2</small> | 92.8 ~ 232V | 62 ~ 155V | 46.4 ~ 116V | 24 ~ 58V |
| | FULL POWER CURRENT RANGE | 2800~3500mA | 4200~5250mA | 5600~7000mA | 11200~14000mA |
| | OPEN CIRCUIT VOLTAGE (max.) | 240V | 160V | 120V | 70V |
| | CURRENT ADJ. RANGE | 1400~3500mA | 2100~5250mA | 2800~7000mA | 5600~14000mA |
| | CURRENT RIPPLE | 5.0% max. @rated current | | | |
| | CURRENT TOLERANCE | ±5% | | | |
| | AUXILIARY POWER | Nominal 12V (Tolerance: ±10%, R&N:150mVp-p)@200mA for HVGC-650A only | | | |
| SET UP TIME <small>Note.4</small> | 500ms/230VAC, 347VAC, 480VAC | | | | |
| INPUT | VOLTAGE RANGE <small>Note.3</small> | 180 ~ 528VAC 254VDC ~ 747VDC (Please refer to "STATIC CHARACTERISTIC" section) | | | |
| | FREQUENCY RANGE | 47 ~ 63Hz | | | |
| | POWER FACTOR (Typ.) | PF ≥ 0.98 / 230VAC, PF ≥ 0.98 / 277VAC, PF ≥ 0.97 / 347VAC, PF ≥ 0.96 / 400VAC, PF ≥ 0.95 / 480VAC at full load (Please refer to "Power Factor Characteristic" section) | | | |
| | TOTAL HARMONIC DISTORTION | THD < 20% (@ load ≥ 50% at 230VAC/277VAC/347VAC/400VAC/480VAC input (Please refer to "TOTAL HARMONIC DISTORTION (THD)" section) | | | |
| | EFFICIENCY (Typ.) | 95% | 95% | 95% | 95.5% |
| | AC CURRENT (Typ.) | 2.1A / 347VAC 1.5A / 480VAC | | | |
| | INRUSH CURRENT(Typ.) | COLD START 40A(<small>t</small> width=1250μs measured at 50% I _{peak}) at 480VAC; Per NEMA 410 | | | |
| | MAX. NO. of PSUs on 16A CIRCUIT BREAKER | 2 unit(circuit breaker of type B) / 4 units(circuit breaker of type C) at 480VAC | | | |
| LEAKAGE CURRENT | <0.75mA / 480VAC | | | | |
| PROTECTION | SHORT CIRCUIT | Constant current limiting, recovers automatically after fault condition is removed | | | |
| | OVER VOLTAGE | 240 ~ 259V | 158 ~ 178V | 118 ~ 136V | 62 ~ 78V |
| | OVER TEMPERATURE | Shut down output voltage, re-power on to recovery | | | |
| ENVIRONMENT | WORKING TEMP. | T _{case} =-40 ~ +85°C (Please refer to "OUTPUT LOAD vs TEMPERATURE" section) | | | |
| | MAX. CASE TEMP. | T _{case} =+85°C | | | |
| | WORKING HUMIDITY | 20 ~ 95% RH non-condensing | | | |
| | STORAGE TEMP., HUMIDITY | -40 ~ +80°C, 10 ~ 95% RH non-condensing | | | |
| | TEMP. COEFFICIENT | ±0.03%/°C (0 ~ 55°C) | | | |
| | VIBRATION | 10 ~ 500Hz, 5G 12min./1cycle, period for 72min. each along X, Y, Z axes | | | |
| SAFETY & EMC | SAFETY STANDARDS | UL8750 (type"HL"), CSA C22.2 No. 250.13-12, ENEC BS EN/EN613471-2-13, BS EN/EN60384, IP67, EAC TP TC 004, GB19510.1,GB19510.14(for AB-Type only) approved | | | |
| | WITHSTAND VOLTAGE | I/P-O/P:4.2KVAC I/P-FG:2.1KVAC O/P-FG:1.5KVAC | | | |
| | ISOLATION RESISTANCE | I/P-O/P, I/P-FG, O/P-FG:100M Ohms / 500VDC / 25°C / 70% RH | | | |
| | EMC EMISSION | Compliance to BS EN/EN55015, BS EN/EN61000-3-2 Class C (@ load ≥ 50%); BS EN/EN61000-3-3, FCC Part 15 class B, GB/T 17743 , GB17625.1(for AB-Type only),EAC TP TC 020 | | | |
| | EMC IMMUNITY | Compliance to BS EN/EN61000-4-2,3,4,5,6,8,11, BS EN/EN61547, light industry level (surge immunity Line-Earth 8KV, Line-Line 4KV), EAC TP TC 020 | | | |
| OTHERS | MTBF | 728.1K hrs min. Telcordia SR-332(Bellcore) ; 60.2K hrs min. MIL-HDBK-217F (25°C) | | | |
| | DIMENSION | 280*144*48.5mm (L*W*H) | | | |
| | PACKING | 3.9Kg;4pcs/16.6Kg/0.98CUFT | | | |
| NOTE | <ol style="list-style-type: none"> All parameters NOT specially mentioned are measured at 347VAC input, rated current and 25°C of ambient temperature. Please refer to "DRIVING METHODS OF LED MODULE". De-rating may be needed under low input voltages. Please refer to "STATIC CHARACTERISTIC" sections for details. Length of set up time is measured at first cold start. Turning ON/OFF the power supply may lead to increase of the set up time. The driver is considered as a component that will be operated in combination with final equipment. Since EMC performance will be affected by the complete installation, the final equipment manufacturers must re-qualify EMC Directive on the complete installation again. (as available on https://www.meanwell.com/Upload/PDF/EMI_statement_en.pdf) This series meets the typical life expectancy of >50,000 hours of operation when T_{case}, particularly (t_c) point (or TMP, per DLC), is about 80°C or less. Please refer to the warranty statement on MEAN WELL's website at http://www.meanwell.com To fulfill requirements of the latest ErP regulation for lighting fixtures, this LED driver can only be used behind a switch without permanently connected to the mains. The ambient temperature derating of 3.5°C/1000m with fanless models and of 5°C/1000m with fan models for operating altitude higher than 2000m(6500ft). For any application note and IP water proof function installation caution, please refer our user manual before using. https://www.meanwell.com/Upload/PDF/LED_EN.pdf <p>※ Product Liability Disclaimer : For detailed information, please refer to https://www.meanwell.com/serviceDisclaimer.aspx</p> | | | | |

■ BLOCK DIAGRAM

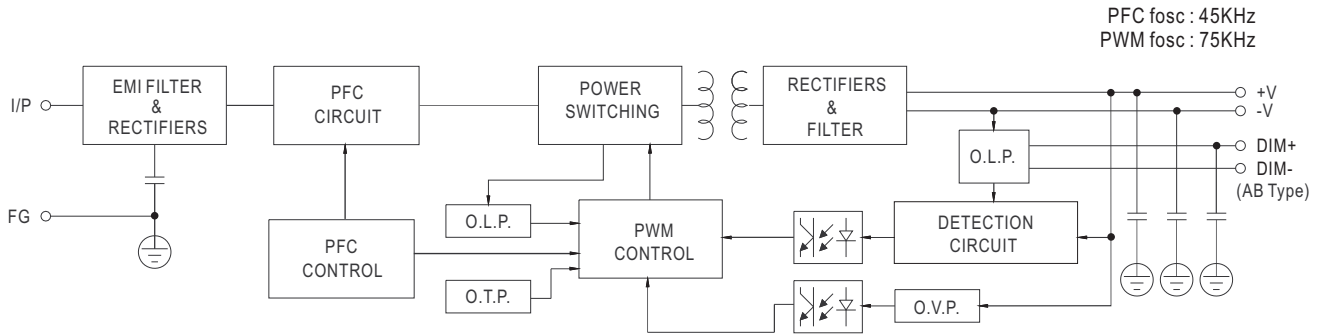

■ DRIVING METHODS OF LED MODULE

※ I-V Operating Area

◎ HVGC-650-L

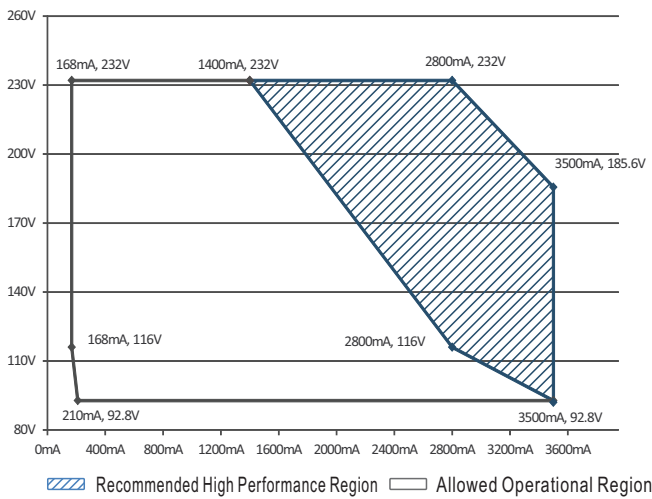

◎ HVGC-650-M

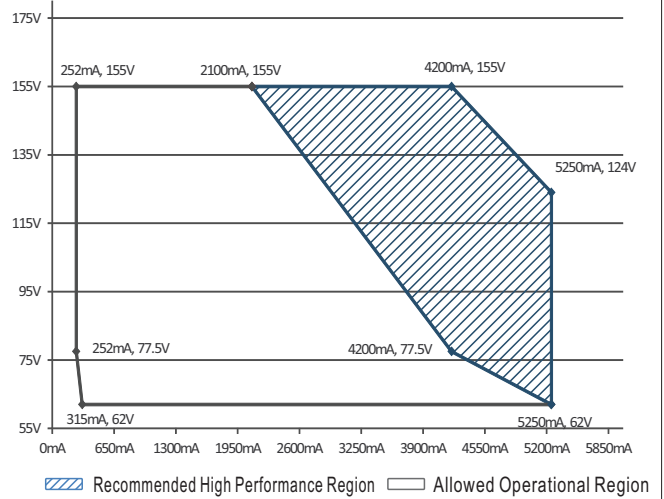

◎ HVGC-650-H

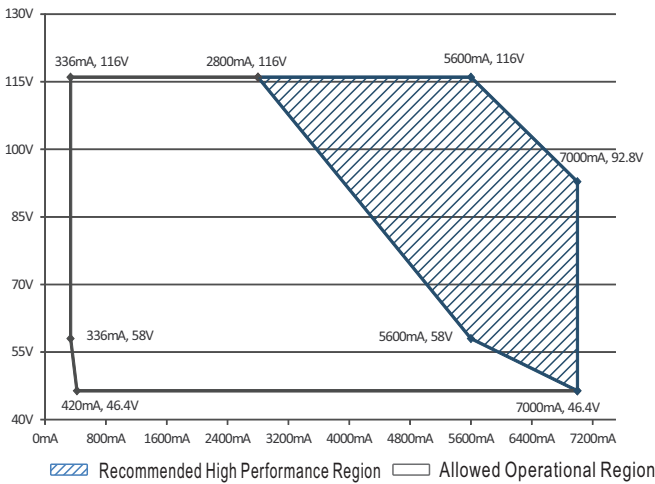

◎ HVGC-650-U

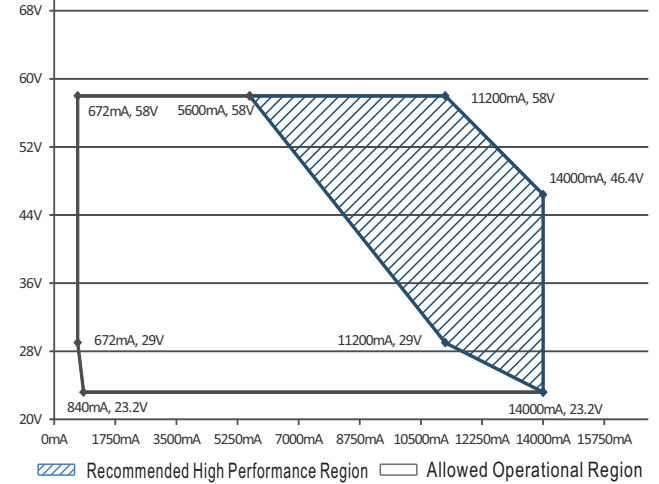

■ DIMMING OPERATION

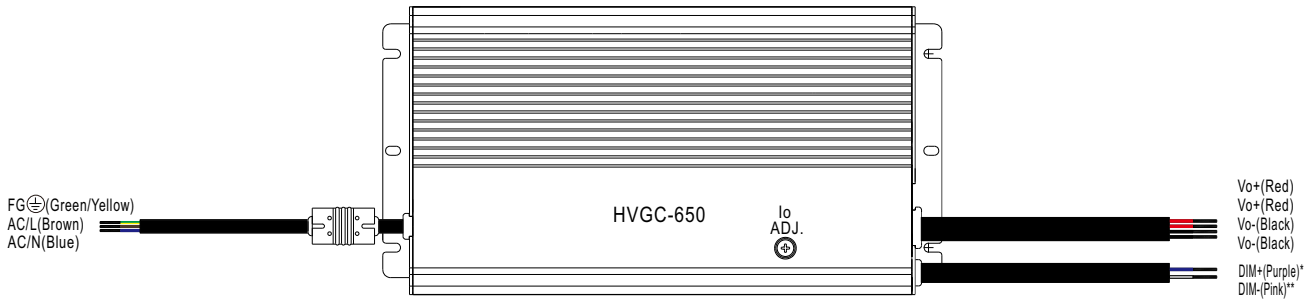

※ 3 in 1 dimming function (for Blank-Type)

- Output constant current level can be adjusted by applying one of the three methodologies between DIM+ and DIM-: 0 ~ 10VDC, or 10V PWM signal or resistance.
- Direct connecting to LEDs is suggested. It is not suitable to be used with additional drivers.
- Dimming source current from power supply: 100 μ A (typ.)

* DIM+ for AB-Type
 PROG+ for D2-Type
 DA+ for DA-Type
 * DIM- for AB-Type
 PROG- for D2-Type
 DA- for DA-Type

◎ Applying additive 0 ~ 10VDC

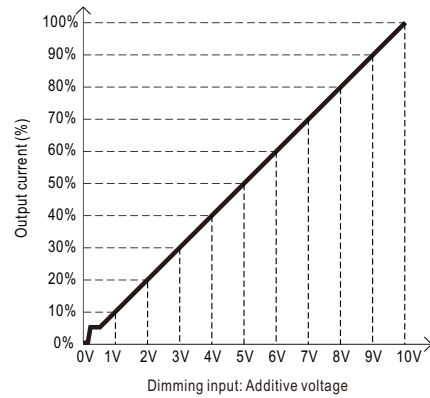
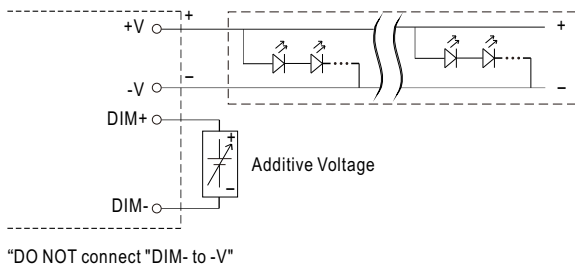

◎ Applying additive 10V PWM signal (frequency range 100Hz ~ 3KHz):

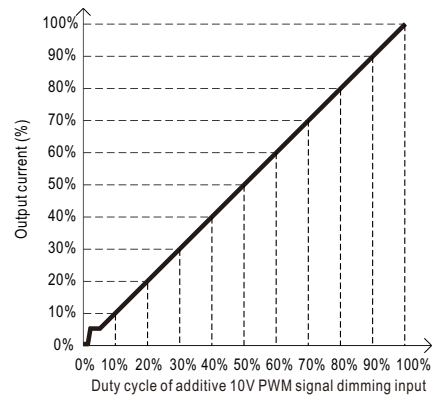
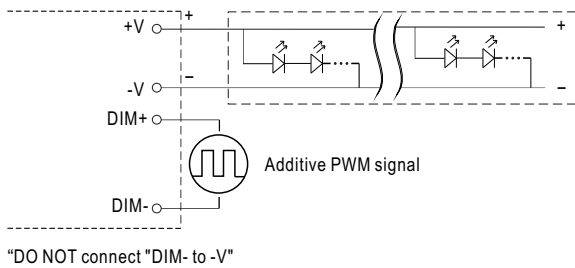

◎ Applying additive resistance:

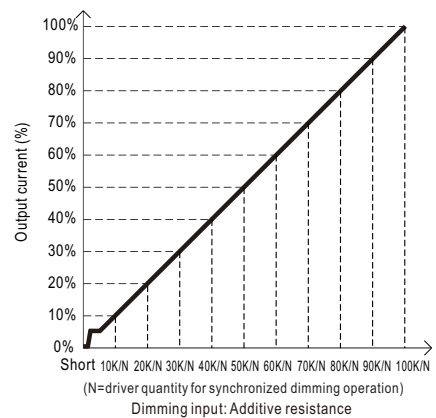
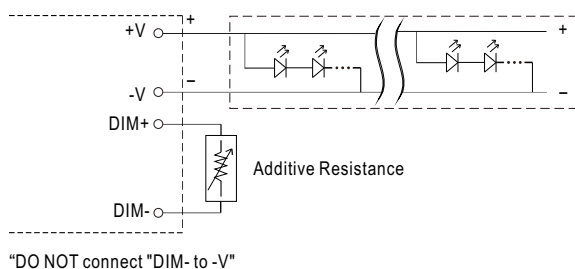

Note : 1. Min. dimming level is about 6% and the output current is not defined when 0% < Iout < 6%.
 2. The output current could drop down to 0% when dimming input is about 0k Ω or 0Vdc, or 10V PWM signal with 0% duty cycle.

※ **Smart timer dimming function (for Dxx-Type by User definition)**

MEAN WELL Smart timer dimming primarily provides the adaptive proportion dimming profile for the output constant current level to perform up to 14 consecutive hours. 3 dimming profiles hereunder are defined accounting for the most frequently seen applications. If other options may be needed, please contact MEAN WELL for details.

Ex : ☉ D01-Type: the profile recommended for residential lighting

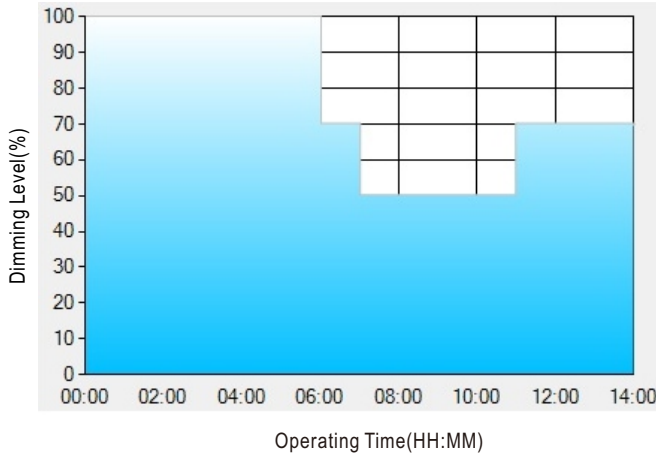

Set up for D01-Type in Smart timer dimming software program:

| | T1 | T2 | T3 | T4 |
|---------|-------|-------|-------|-----|
| TIME** | 06:00 | 07:00 | 11:00 | --- |
| LEVEL** | 100% | 70% | 50% | 70% |

** : TIME matches Operating Time in the diagram whereas LEVEL matches Dimming Level.

Example: If a residential lighting application adopts D01-Type, when turning on the power supply at 6:00pm, for instance:

- [1] The power supply will switch to the constant current level at 100% starting from 6:00pm.
 - [2] The power supply will switch to the constant current level at 70% in turn, starting from 0:00am, which is 06:00 after the power supply turns on.
 - [3] The power supply will switch to the constant current level at 50% in turn, starting from 1:00am, which is 07:00 after the power supply turns on.
 - [4] The power supply will switch to the constant current level at 70% in turn, starting from 5:00am, which is 11:00 after the power supply turns on.
- The constant current level remains till 8:00am, which is 14:00 after the power supply turns on.

Ex : ☉ D02-Type: the profile recommended for street lighting

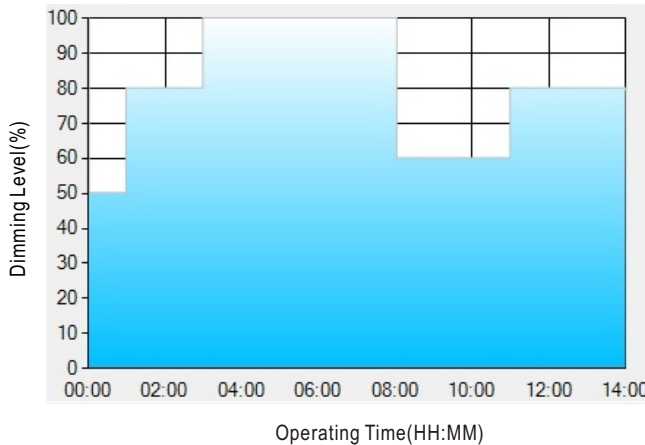

Set up for D02-Type in Smart timer dimming software program:

| | T1 | T2 | T3 | T4 | T5 |
|---------|-------|-------|------|-------|-----|
| TIME** | 01:00 | 03:00 | 8:00 | 11:00 | --- |
| LEVEL** | 50% | 80% | 100% | 60% | 80% |

** : TIME matches Operating Time in the diagram whereas LEVEL matches Dimming Level.

Example: If a street lighting application adopts D02-Type, when turning on the power supply at 5:00pm, for instance:

- [1] The power supply will switch to the constant current level at 50% starting from 5:00pm.
- [2] The power supply will switch to the constant current level at 80% in turn, starting from 6:00pm, which is 01:00 after the power supply turns on.
- [3] The power supply will switch to the constant current level at 100% in turn, starting from 8:00pm, which is 03:00 after the power supply turns on.
- [4] The power supply will switch to the constant current level at 60% in turn, starting from 1:00am, which is 08:00 after the power supply turns on.
- [5] The power supply will switch to the constant current level at 80% in turn, starting from 4:00am, which is 11:00 after the power supply turns on. The constant current level remains till 6:30am, which is 14:00 after the power supply turns on.

Ex: ☉ D03-Type: the profile recommended for tunnel lighting

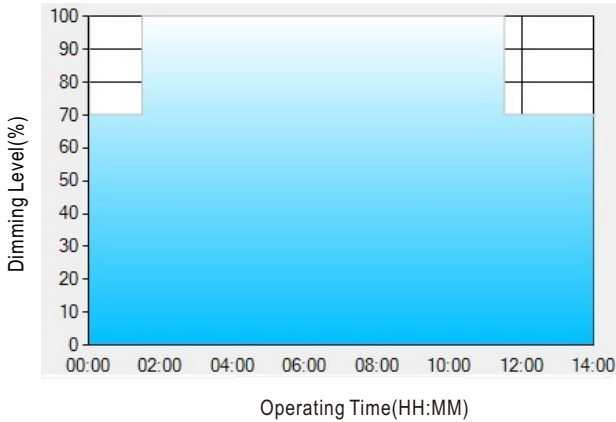

Set up for D03-Type in Smart timer dimming software program:

| | T1 | T2 | T3 | T4 |
|---------|-------|-------|-------|-------|
| TIME** | 18:00 | 20:00 | 24:00 | 04:00 |
| LEVEL** | 100% | 75% | 50% | 25% |

** : TIME matches Operating Time in the diagram whereas LEVEL matches Dimming Level.

Example: If a tunnel lighting application adopts D03-Type, when turning on the power supply at 4:30pm, for instance:

[1] The power supply will switch to the constant current level at 70% starting from 4:30pm.

[2] The power supply will switch to the constant current level at 100% in turn, starting from 6:00pm, which is 01:30 after the power supply turns on.

[3] The power supply will switch to the constant current level at 70% in turn, starting from 5:00am, which is 11:00 after the power supply turns on.

The constant current level remains till 6:30am, which is 14:00 after the power supply turns on.

※ **DALI interface(primary side; for DA-Type)**

- Apply DALI signal between DA+ and DA-.
- DALI protocol comprises 16 groups and 64 addresses.
- First step is fixed at 6% of output.

OUTPUT LOAD vs TEMPERATURE

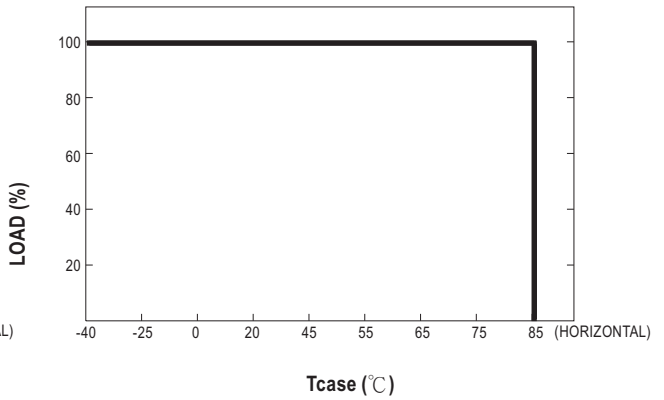
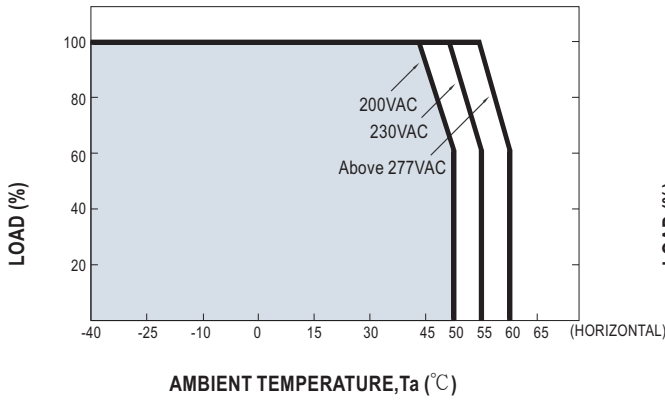

If HVGC-650 operates in Constant Power mode with the rated current, the maximum workable Ta is 50°C (Typ. 230VAC)

STATIC CHARACTERISTIC

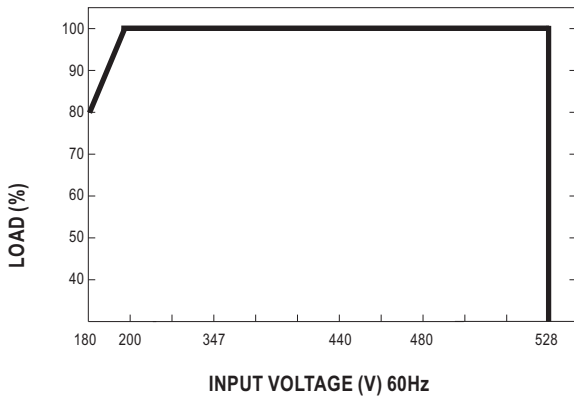

POWER FACTOR (PF) CHARACTERISTIC

※ Tcase at 80°C

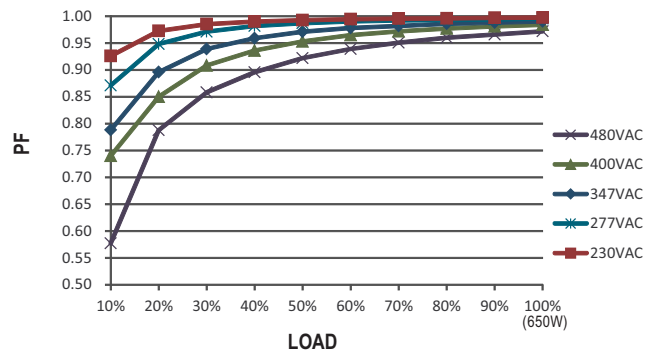

TOTAL HARMONIC DISTORTION (THD)

※ L Model, Tcase at 80°C

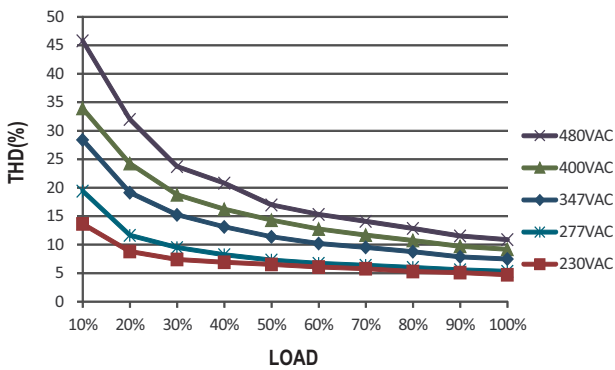

EFFICIENCY vs LOAD

HVGC-650 series possess superior working efficiency that up to 95% can be reached in field applications.

※ L Model, Tcase at 80°C

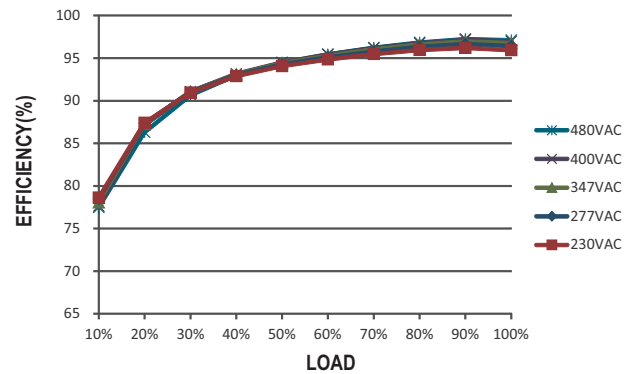

LIFE TIME

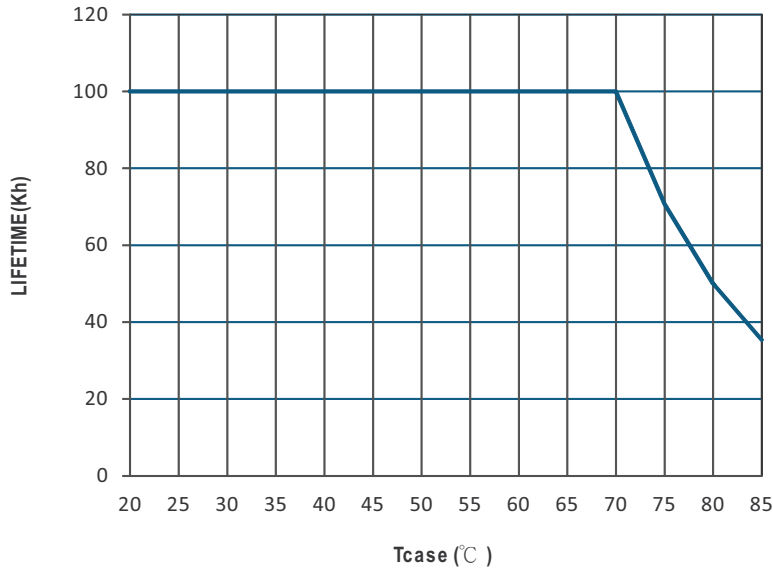

MECHANICAL SPECIFICATION

Cable information

| Type | Input cable | Output cable | Dimming cable | AUX cable |
|------|---|--|-------------------------|-------------------------|
| AB | SOOW 17AWG×3C / H07RN-F 3G 1.0mm ² | U type: SJOW 17AWG×4C / H05RN-F L/M/H type: SJOW 17AWG×2C / H05RN-F | SJOW 17AWG×2C / H05RN-F | SJOW 17AWG×2C / H05RN-F |
| D2 | SOOW 17AWG×3C / H07RN-F 3G 1.0mm ² | U type: SJOW 17AWG×4C / H05RN-F L/M/H type: SJOW 17AWG×2C / H05RN-F | SJOW 17AWG×2C / H05RN-F | SJOW 17AWG×2C / H05RN-F |
| Dx | SOOW 17AWG×3C / H07RN-F 3G 1.0mm ² | U type: SJOW 17AWG×4C / H05RN-F L/M/H type: SJOW 17AWG×2C / H05RN-F | ----- | SJOW 17AWG×2C / H05RN-F |
| DA | SOOW 17AWG×3C / H07RN-F 3G 1.0mm ² | U type: SJOW 17AWG×4C / H05RN-F L/M/H type: SJOW 17AWG×2C / H05RN-F | SJOW 17AWG×2C / H05RN-F | SJOW 17AWG×2C / H05RN-F |

Case No. 228 Unit:mm

※HVGC-650-□-□
 □ = U type
 □ = AB/D2/DA types

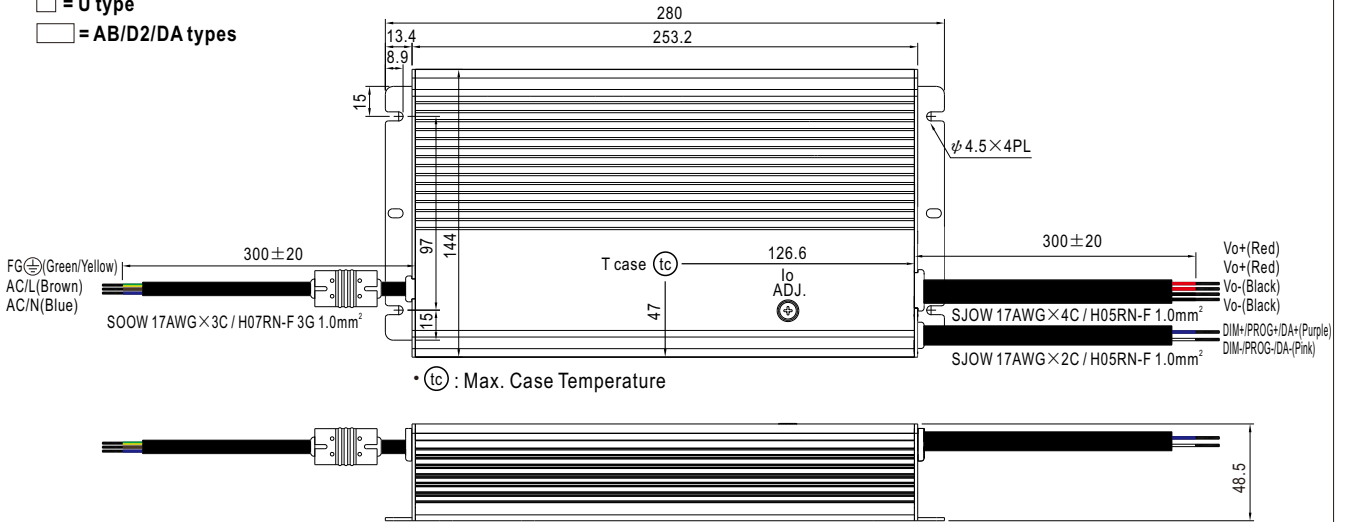

※HVGC-650-□-□
 □ = L/M/H type
 □ = AB/D2/DA types

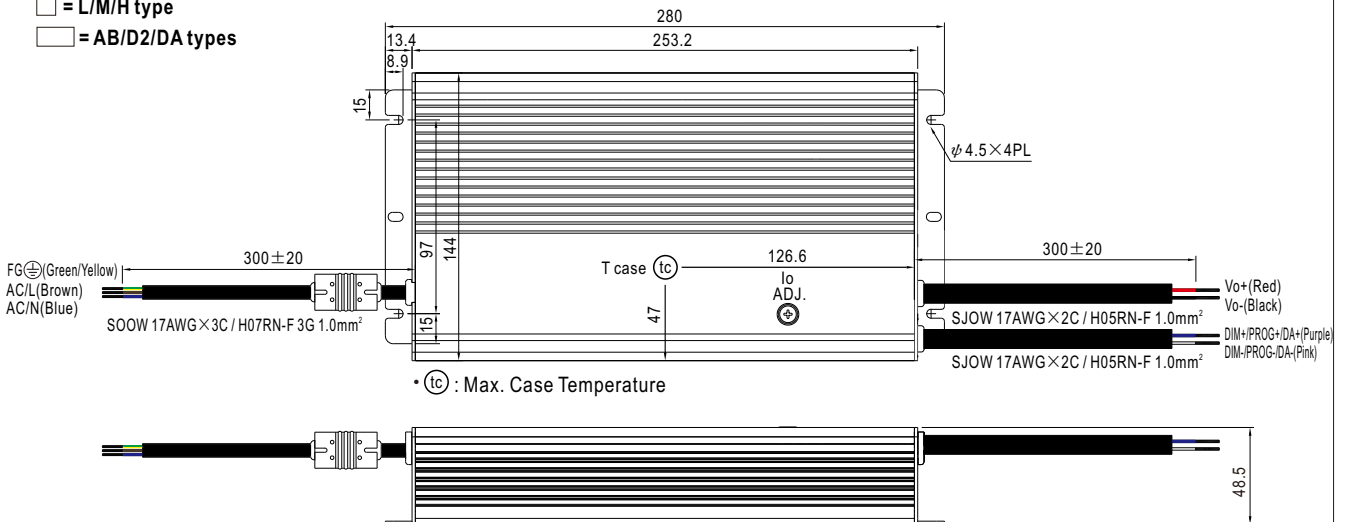

Unit:mm

※HVGC-650A-□-□ with auxiliary power optional

- = U type
- = AB/D2/DA types

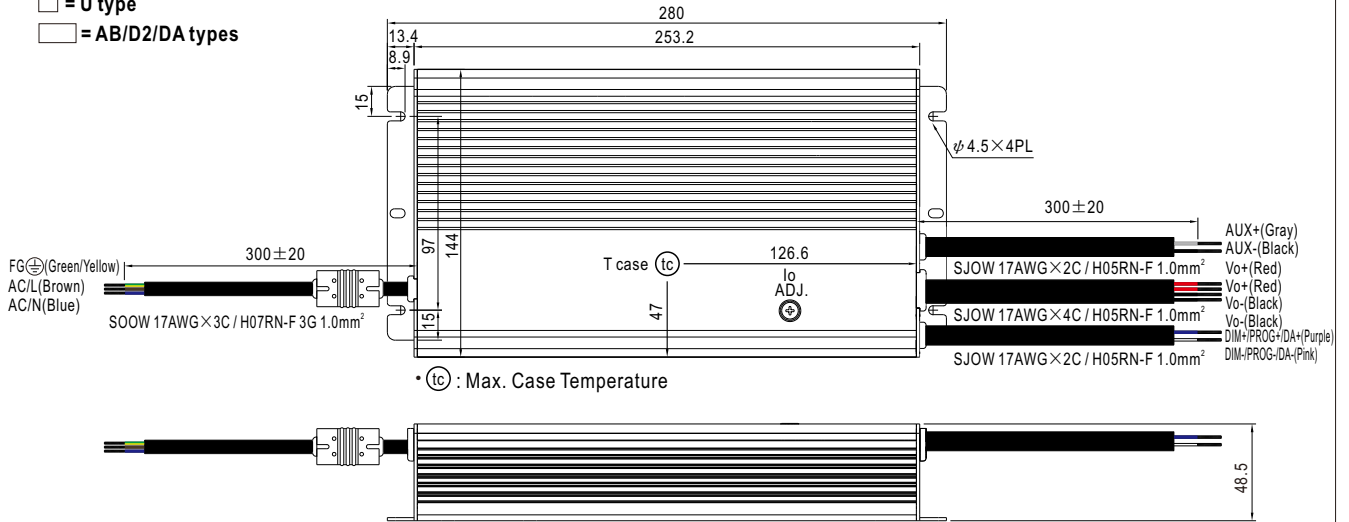

• (tc) : Max. Case Temperature

※HVGC-650A-□-□ with auxiliary power optional

- = L/M/H type
- = AB/D2/DA types

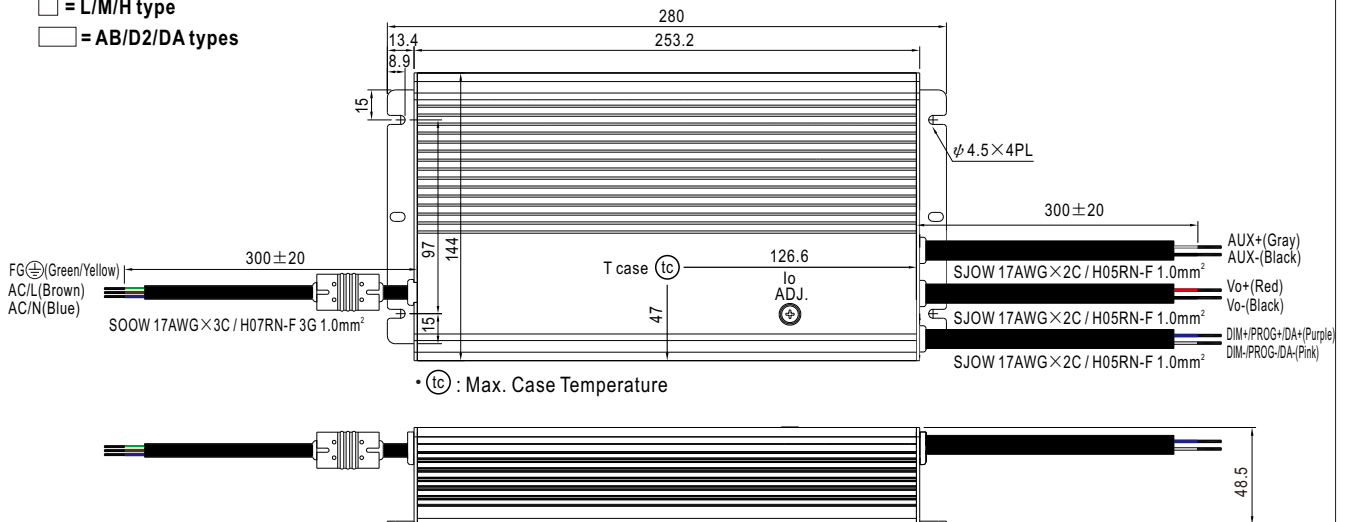

• (tc) : Max. Case Temperature

■ INSTALLATION MANUAL

Please refer to : <http://www.meanwell.com/manual.html>