



200W Constant Voltage PWM Output KNX LED Driver **PWM-200KN** series



■ Features

- Constant Voltage PWM style output with user changeable frequency up to 4KHz compliant IEEE1789-2015 and EU Ecodesign SVM requirement
- Min. dimming level 0.01%
- Plastic housing with class II design
- Standby power consumption < 0.5W
- Support KNX Data Secure
- No need KNX-DALI gateway
- Typical lifetime > 50000 hours
- 5 years warranty

■ Applications

- LED strip lighting
- Indoor LED lighting
- LED decorative lighting
- LED architecture lighting
- Type "HL" for use in class I, division 2 hazardous (classified) location.
- Cove lighting
- Industrial lighting

■ GTIN CODE

MW Search: <https://www.meanwell.com/serviceGTIN.aspx>

■ Description

PWM-200KN series is a 200W AC/DC LED driver featuring the constant voltage mode with PWM style output, which is able to maintain the colour temperature and the brightness homogeneity when driving all kinds of LED strips and constant voltage LED bulbs. The built-in KNX interface is to avoid using the complicated KNX-DALI gateway and equipped with KNX Data Secure. KNX Data Secure offers protection against manipulation in building automation and can be configured in the ETS project. PWM-200KN operates from 100~305VAC and offers models with output voltage between 12V & 48V. Thanks to the high efficiency up to 94%, with the fanless design, the entire series is able to operate for -40°C ~ +85°C case temperature under free air convection. The minimal dimming level low to 0.01% is suitable for low light level applications e.g. cinema. The output frequency is changeable up to 4KHz compliant IEEE1789-2015 no risk requirement and EU Ecodesign stroboscopic visibility measure (SVM) requirement providing a great solution for health concern due to light flickering.

■ Model Encoding

PWM - 200 - 48

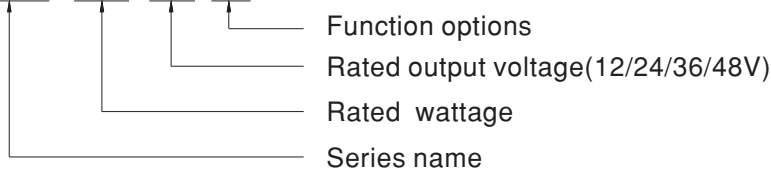

Type	Function	Note
KN	KNX control technology	In stock

SPECIFICATION

MODEL		PWM-200-12 <input type="checkbox"/>	PWM-200-24 <input type="checkbox"/>	PWM-200-36 <input type="checkbox"/>	PWM-200-48 <input type="checkbox"/>
OUTPUT	DC VOLTAGE	12V	24V	36V	48V
	RATED CURRENT	15A	8.3A	5.55A	4.17A
	RATED POWER	180W	199.2W	199.8W	200.1W
	DIMMING RANGE	0 ~ 100%			
	PWM FREQUENCY (Typ.)	200~4000Hz user changable via ETS			
	SETUP, RISE TIME <small>Note.2</small>	500ms, 80ms/230VAC, 1200ms, 80ms/115VAC			
	HOLD UP TIME (Typ.)	10ms/230VAC or 115VAC			
INPUT	VOLTAGE RANGE <small>Note.3</small>	100 ~ 305VAC 142 ~ 431VDC (Please refer to "STATIC CHARACTERISTIC" section)			
	FREQUENCY RANGE	47 ~ 63Hz			
	POWER FACTOR (Typ.)	PF>0.97/115VAC, PF>0.96/230VAC, PF>0.94/277VAC @ full load (Please refer to "POWER FACTOR (PF) CHARACTERISTIC" section)			
	TOTAL HARMONIC DISTORTION	THD<20%(@load≥60%/115VAC, 230VAC; @load≥75%/277VAC) (Please refer to "TOTAL HARMONIC DISTORTION" section)			
	EFFICIENCY (Typ.)	92%	93%	94%	94%
	AC CURRENT (Typ.)	2.2A / 115VAC	1.1A / 230VAC	0.9A / 277VAC	
	INRUSH CURRENT (Typ.)	COLD START 65A(twidth=550μs measured at 50% Ipeak) at 230VAC; Per NEMA 410			
	MAX. NO. of PSUs on 16A CIRCUIT BREAKER	3 units (circuit breaker of type B) / 5 units (circuit breaker of type C) at 230VAC			
	LEAKAGE CURRENT	<0.75mA / 277VAC			
	STANDBY POWER CONSUMPTION	standby power consumption<0.5W when dimming off			
PROTECTION	OVERLOAD	108 ~ 135% rated output power Hiccup mode or Constant current limiting, recovers automatically after fault condition is removed			
	SHORT CIRCUIT	Shut down o/p voltage, re-power on to recover			
	OVER VOLTAGE	13 ~ 18V	27 ~ 34V	41 ~ 49V	53 ~ 65V
	OVER TEMPERATURE	Shut down o/p voltage, re-power on to recover after fault condition is removed			
ENVIRONMENT	WORKING TEMP.	Tcase=-40 ~ +85°C (Please refer to " OUTPUT LOAD vs TEMPERATURE" section)			
	MAX. CASE TEMP.	Tcase=+85°C			
	WORKING HUMIDITY	20 ~ 95% RH non-condensing			
	STORAGE TEMP., HUMIDITY	-40 ~ +80°C, 10 ~ 95% RH			
	TEMP. COEFFICIENT	±0.03%/°C (0 ~ 50°C)			
SAFETY & EMC	SAFETY STANDARDS <small>Note.5</small>	UI8750(type "HL"), CSA C22.2 No. 250.13-12; ENEC BS EN/EN61347-1, BS EN/EN61347-2-13,BS EN/EN62384 independent, EAC TP TC 004, GB19510.1,GB19510.14, IS15885(Part2/Sec13)(except for 36V) approved; Design refer to BS EN/EN60335-1, According to BS EN/EN61347-2-13 appendix J suitable for emergency installations			
	KNX STANDARDS	Certified protocol			
	WITHSTAND VOLTAGE	I/P-O/P: 3.75KVAC			
	ISOLATION RESISTANCE	I/P-O/P: 100M Ohms / 500VDC / 25°C / 70% RH			
	EMC EMISSION <small>Note.6</small>	Compliance to BS EN/EN55015, BS EN/EN61000-3-2 Class C (@load≥60%) ; BS EN/EN61000-3-3, GB/T 17743, GB17625.1;EAC TP TC 020			
EMC IMMUNITY	Compliance to BS EN/EN61000-4-2,3,4,5,6,8,11; BS EN/EN61547, light industry level (surge immunity, Line-Line 2KV),EAC TP TC 020				
OTHERS	MTBF	1658.9 K hrs min. Telcordia SR-332 (Bellcore) ; 170 .0K hrs min. MIL-HDBK-217F (25°C)			
	DIMENSION	195*68*39.5mm (L*W*H)			
	PACKING	1.03Kg; 12pcs/13.4Kg/0.71CUFT			
NOTE	<p>1. All parameters NOT specially mentioned are measured at 230VAC input, rated current and 25°C of ambient temperature.</p> <p>2. Length of set up time is measured at first cold start. Turning ON/OFF the driver may lead to increase of the set up time.</p> <p>3. De-rating may be needed under low input voltages. Please refer to "STATIC CHARACTERISTIC" sections for details.</p> <p>4. The driver is considered as a component that will be operated in combination with final equipment. Since EMC performance will be affected by the complete installation, the final equipment manufacturers must re-qualify EMC Directive on the complete installation again. (as available on https://www.meanwell.com/Upload/PDF/EML_statement_en.pdf)</p> <p>5. This series meets the typical life expectancy of >50,000 hours of operation when Tcase, particularly (tc) point (or TMP, per DLC), is about 75°C or less.</p> <p>6. Please refer to the warranty statement on MEAN WELL's website at http://www.meanwell.com</p> <p>7. The ambient temperature derating of 3.5°C/1000m with fanless models and of 5°C/1000m with fan models for operating altitude higher than 2000m(6500ft).</p> <p>8. For any application note and IP water proof function installation caution, please refer our user manual before using. https://www.meanwell.com/Upload/PDF/LED_EN.pdf</p> <p>9. It is not recommended to connect to capacitive loads</p> <p>10. To fulfill requirements of the latest ErP regulation for lighting fixtures, this LED power supply can only be used behind a switch without permanently connected to the mains.</p> <p>※ Product Liability Disclaimer : For detailed information, please refer to https://www.meanwell.com/serviceDisclaimer.aspx</p>				

■ DIMMING OPERATION

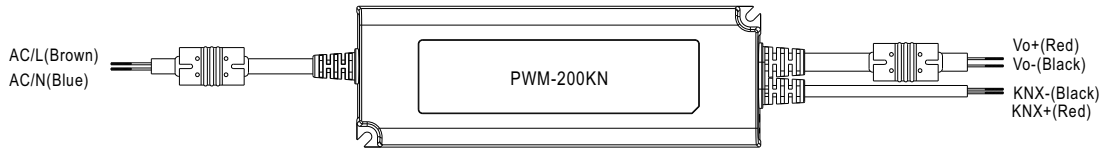

※ Dimming principle for PWM style output

- Dimming is achieved by varying the duty cycle of the output current.

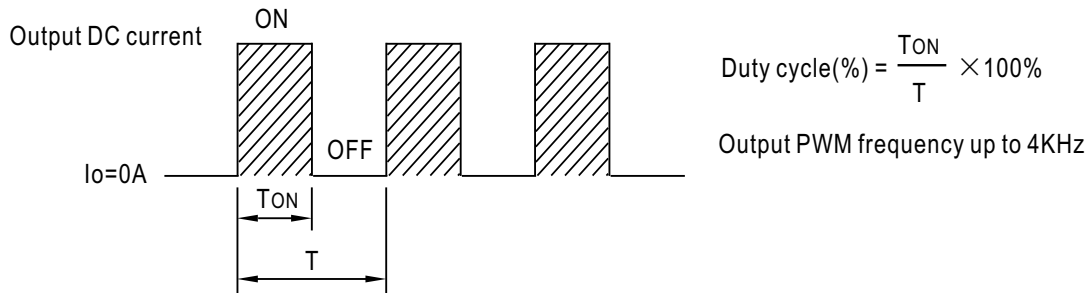

※ KNXInterface

- Apply KNX signal between KNX+ and KNX-.

The application program(database) can be downloaded via Online Catalogs from ETS or via <http://www.meanwell.com/productCatalog.aspx>

Parametrization options	Description
Switch functions	Turn on brightness Dimming speed for turn on/off Switch telegram and status Switch on/off delay
Dimming	Dimming speed for 0~100% Allow switch on via relative dimming
Brightness value	Dimming speed for transition brightness values Permit set switch on and off brightness via value Brightness value and status

More parameters can be found in the ETS application database and instruction manual

The device is equipped with KNX Data Secure. KNX Data Secure offers protection against manipulation in building automation and can be configured in the ETS project. Detailed specialist knowledge is required. A device certificate, which is attached to the device, is required for the first configuration. After configuration and ready for runtime (daily) operation, it is recommended to remove the certificate from the device and to store it securely. For details, please refer to the instruction manual.



OUTPUT LOAD vs TEMPERATURE

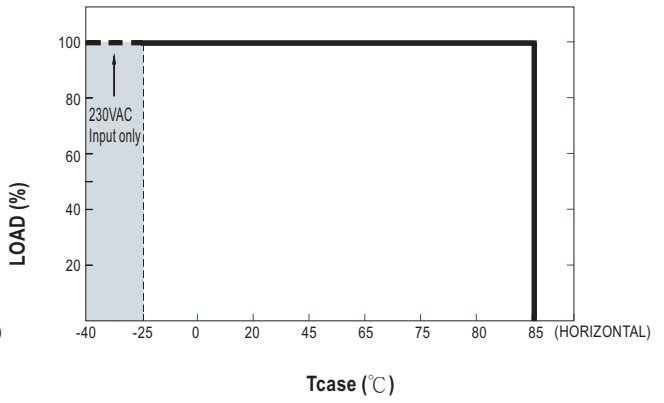
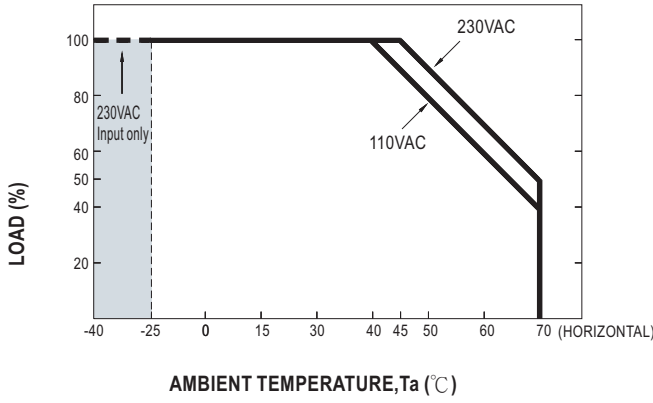

STATIC CHARACTERISTIC

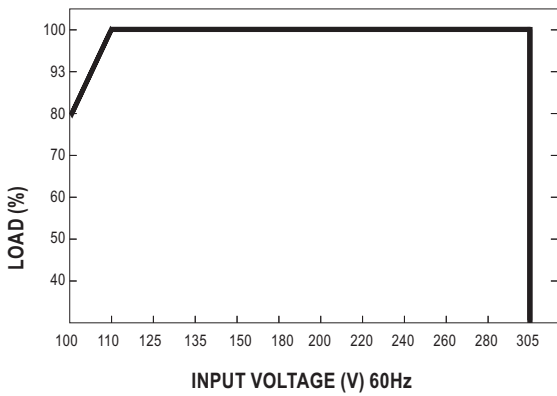

POWER FACTOR (PF) CHARACTERISTIC

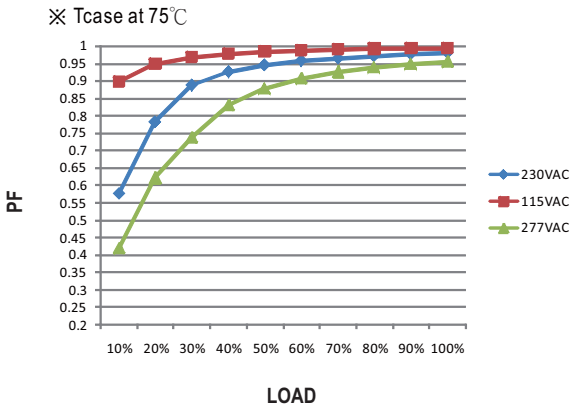

TOTAL HARMONIC DISTORTION (THD)

※ 48V Model, T_{case} at 75°C

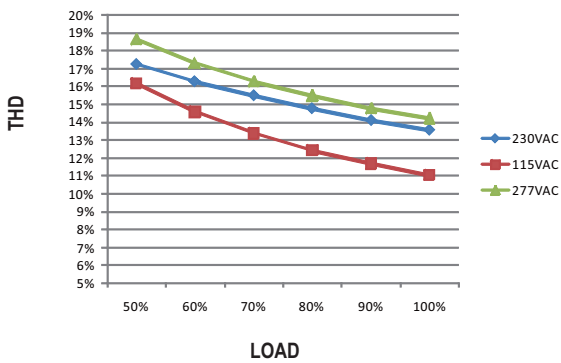

EFFICIENCY vs LOAD

PWM-200KN series possess superior working efficiency that up to 94% can be reached in field applications.

※ 48V Model, T_{case} at 75°C

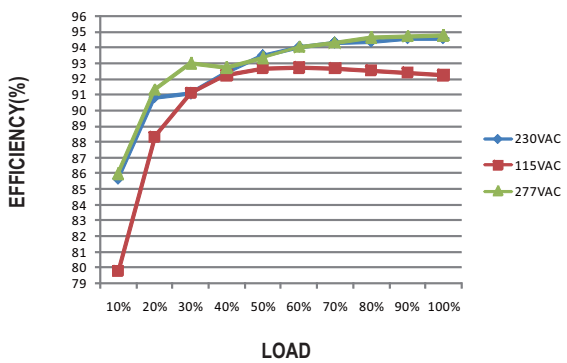



■ LIFE TIME

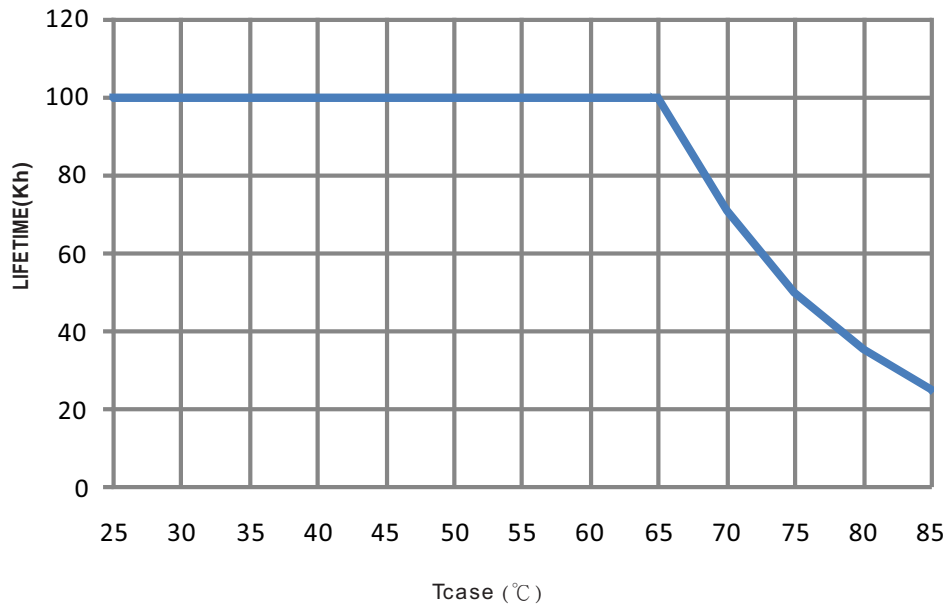

Block Diagram

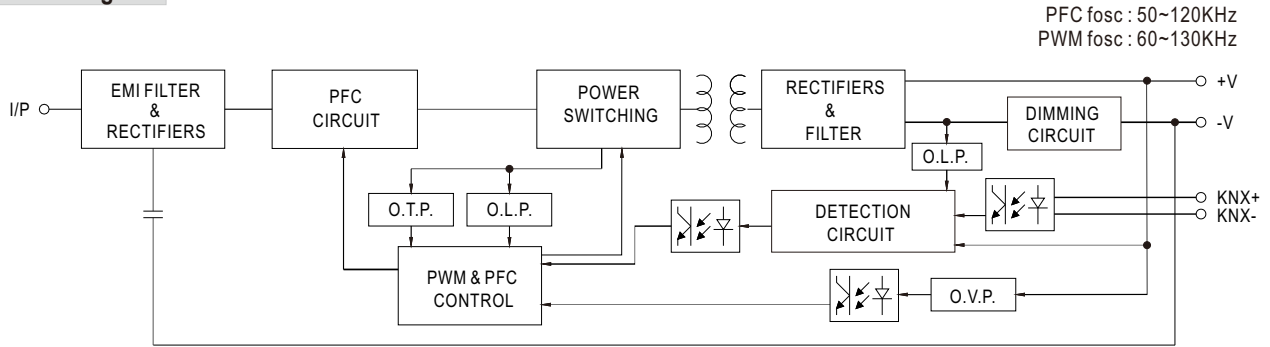

Mechanical Specification

Case No. PWM-200 Unit:mm

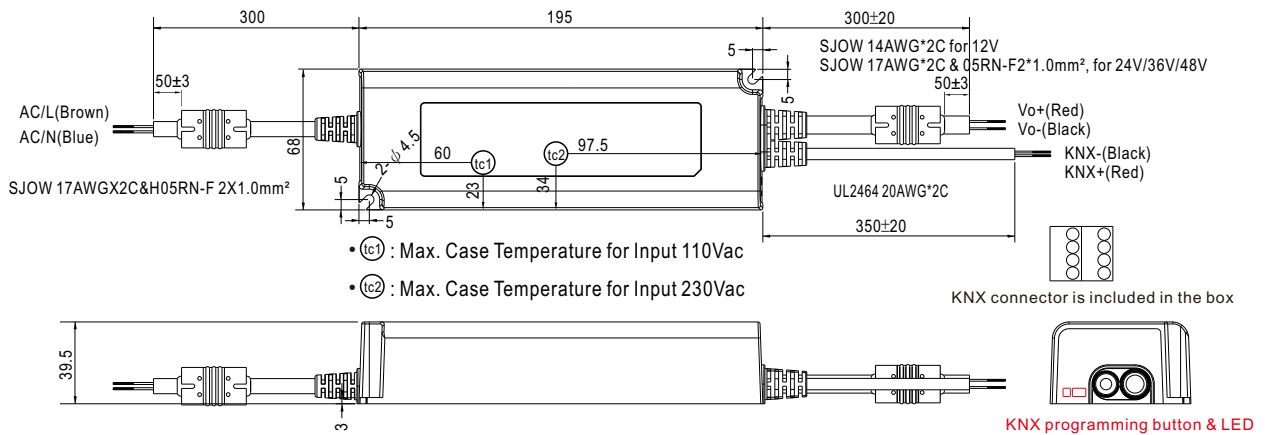

■ **Recommend Mounting Direction**

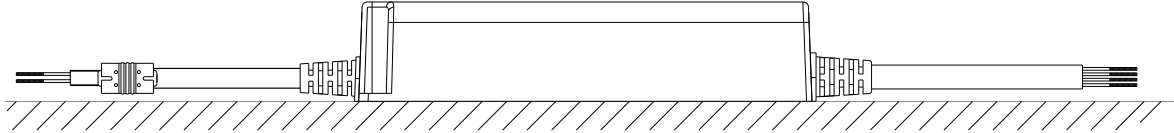

■ **Installation Manual**

◎ **Connection for KN-type**

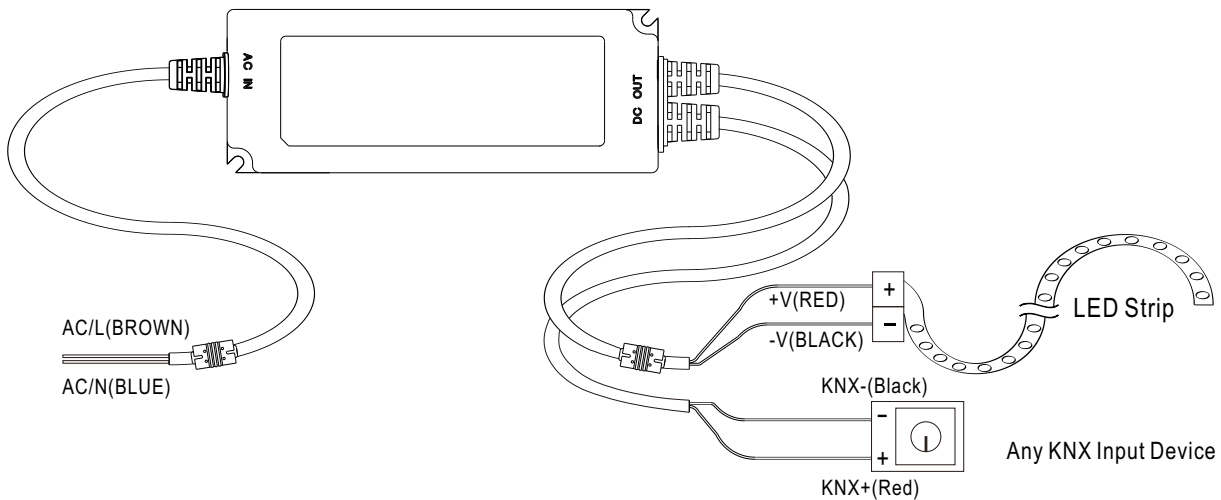

◎ **Cautions**

- Before commencing any installation or maintenance work, please disconnect the power supply from the utility. Ensure that it cannot be re-connected inadvertently!
- Keep proper ventilation around the unit and do not stack any object on it. Also a 10-15 cm clearance must be kept when the adjacent device is a heat source.
- Mounting orientations other than standard orientation or operate under high ambient temperature may increase the internal component temperature and will require a de-rating in output current.
- Current rating of an approved primary /secondary cable should be greater than or equal to that of the unit. Please refer to its specification.
- For LED drivers with waterproof connectors, verify that the linkage between the unit and the lighting fixture is tight so that water cannot intrude into the system.
- Tc max. is identified on the product label. Please make sure that temperature of Tc point will not exceed limit.
- DO NOT connect "KNX- to -V".
- The power supply is considered as a component that will be operated in combination with final equipment. Since EMC performance will be affected by the complete installation, the final equipment manufacturers must re-qualify EMC Directive on the complete installation again.