

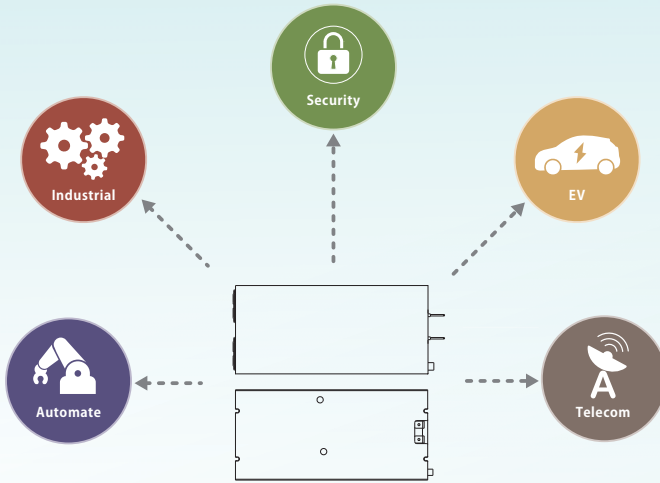

# SHP-10K-HV Series

## Installation manual



### *10KW HVDC Power Supply*

• 3 $\phi$ 3-wire wide input range • High efficiency • Intelligent

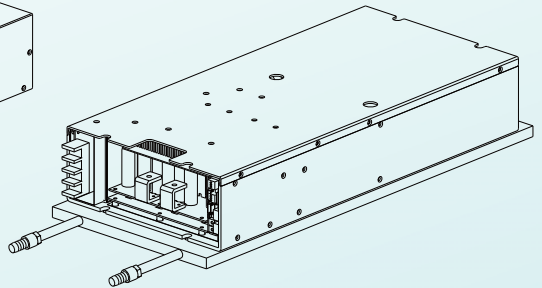
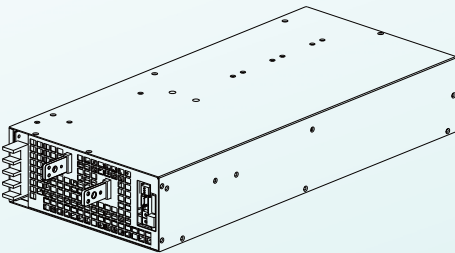

SHP-10K-HV is a 10KW 3 $\psi$ 3W input AC/DC power supply. This series operates for the wide range three phase AC input (3 phase 3 wire / 340~530VAC) neutral is not needed, and offers the models with DC outputs (55V/115V/230V/380V) that mostly demanded by various industries. Two types of cooling methods, forced air and water cooling, that can be working at ambient temperature up to 70°C. Moreover, SHP-10K-HV provides vast design flexibility by equipping various built-in functions such as output programming, active current sharing, remote ON-OFF control, auxiliary power, and communication protocols, that will not only satisfy marker demand, but also enhance automation purpose.

# Contents

<b>1.Safety Guidelines</b>	1	<b>6.Communication Protocol</b>	27
<b>2.Introduction</b>	2	6.1 PMBus Communication Interface	27
2.1 Model Encoding	2	6.2 CANBus Communication Interface	31
2.2 Features	3	6.3 Modbus Communication Interface	40
2.3 Specification	4	6.4 Value range and tolerance	52
2.4 Derating curve	6	<b>7.Protections and Trouble Shooting</b>	54
2.5 Mechanical specification	8	7.1 Protections	54
<b>3.Installation &amp; Wiring</b>	10	7.2 Trouble Shooting	55
3.1 Mounting	10	<b>8.Warranty</b>	56
3.2 Installation Notes	12		
3.3 Cable Size Selection	12		
3.4 AC Power Connection	13		
<b>4.Panel and LED Indicator</b>	14		
4.1 Blank type	14		
4.2 L type	17		
<b>5.Operation</b>	20		
5.1 Inrush Current Limiting	20		
5.2 Power Factor Correction (PFC)	20		
5.3 Output Voltage Adjustment	22		
5.4 Output Current Adjustment	22		
5.5 Parallel function	23		
5.6 Remote Control	25		
5.7 Alarm Signal Output	25		
5.8 Auxiliary Output	26		
5.9 Factory Resetting	26		

## 1.Safety Guidelines

- Risk of electrical shock and energy hazard, all failure should be examined by a qualified technician. Please do not remove the case form the power supply by yourself.
- Please do not change any component on the unit or make any kind of modification on it.
- The input voltage range of 3φ3-wire is 380~480Vac (50/60Hz), please do not feed in voltage that is over or less than 10% of that range.
- Please do not stack any object on the unit.
- The safety protection level of this supply is class I. The Frame "Ground" (≡) of the unit must be well connected to PE (Protective Earth).
- The device should be installed in a Restricted Access Location, such as electric rooms that are accessible only to skilled persons.

## 2.Introduction

### 2.1 Model Encoding

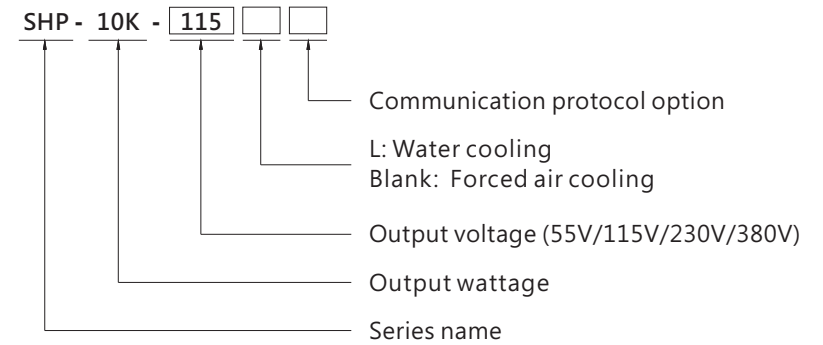

Type	Communication Protocol	Note
Blank	CANBus	In Stock
-PM	PMBus	By request
-MOD	MODBus-RTU/RS-485	By request

## 2.2 Features

- 3φ3-wire without Neutral / 340~530VAC wide input range
- High efficiency up to 97%
- Water/ forced air cooling selectable
- Built-in CAN bus/Optional PMBus/Modbus-RTU/RS-485 protocol
- Output voltage and constant current level programmable
- Active current sharing up to 4 units(40KW)
- Built-in remote ON-OFF control/ auxiliary power/ alarm signal
- Protections: Short circuit/ Overload/ Over voltage/ Over temperature/ Fan fail
- 5 years warranty

## 2.3 Specification

MODEL	SHP-10K-55	SHP-10K-115	SHP-10K-230	SHP-10K-380	
OUTPUT	DC VOLTAGE (factory default)	55V	115V	230V	380V
	CURRENT (factory default)	131A	87A	43.5A	26.3A
	RATED RANGE	0 ~ 150A	0 ~ 87A	0 ~ 46.3A	0 ~ 30A
	RATED POWER (max.)	7200W	10000W	10000W	10000W
	FULL POWER VOLTAGE RANGE	48 ~ 57.6V	115 ~ 138V	216 ~ 260V	334 ~ 400V
	RIPPLE & NOISE (max.) Note.2	0.3Vp-p	0.6Vp-p	1Vp-p	1Vp-p
	VOLTAGE ADJ. RANGE	39 ~ 57.6V	90 ~ 138V	170 ~ 260V	260 ~ 400V
		Can be adjusted via built-in potentiometer			
	VOLTAGE TOLERANCE Note.3	± 1.0%	± 1.0%	± 1.0%	± 1.0%
	LINE REGULATION	± 0.5%	± 0.5%	± 0.5%	± 0.5%
	LOAD REGULATION	± 0.5%	± 0.5%	± 0.5%	± 0.5%
	SETUP, RISE TIME	3000ms, 100ms at full load			
	HOLD UP TIME (Typ.)	25ms / 400VAC at 75% load		20ms / 400VAC at full load	
INPUT	VOLTAGE RANGE Note.5	3φ 3-wire / 340 ~ 530VAC			
	FREQUENCY RANGE	47 ~ 63Hz			
	POWER FACTOR (Typ.)	≥ 0.98/400VAC/480VAC at full load			
	EFFICIENCY (Typ.) Note.6	94.5%	96%	96.5%	96.5%
	AC CURRENT (Typ.)	11.2A/400VAC	9.5A/480VAC	15.7A/400VAC	13A/480VAC
	INRUSH CURRENT (Typ.)	40A/400VAC	65A/480VAC		
	LEAKAGE CURRENT	<6.5mA peak / 530VAC			
PROTECTION	OVERLOAD	100 ~ 105% of rated current Protection type : Constant current limiting, unit will shutdown after 5 sec. re-power on to recover			
	OVER VOLTAGE	60.5 ~ 69.1V	145 ~ 166V	273 ~ 312V	420 ~ 480V
	OVER TEMPERATURE	Shut down O/P voltage, recovers automatically after temperature goes down			
FUNCTION	CURRENT SHARING	Up to 4 units. Please refer to the Function Manual			
	OUTPUT VOLTAGE PROGRAMMABLE	Adjustment of output voltage is allowable to between 50 ~ 120% of nominal output voltage Please refer to the PV curve Function Manual			
	CONSTANT CURRENT LEVEL PROGRAMMABLE	Adjustment of constant current level is allowable to between 20 ~ 100% of rated current Please refer to the PC curve Function Manual			
	AUXILIARY POWER(AUX)	12V@1A tolerance ±5%, ripple 150mVp-p			
	REMOTE ON-OFF CONTROL	Please refer to the Function Manual			
	ALARM SIGNAL OUTPUT	AC-OK, DC-OK, Fan Fail. Please refer to the Function Manual.			
ENVIRON- MENT	DC-OK SIGNAL	The TTL signal output, PSU turn on = -0.5 ~ 0.5V ; PSU turn off = 3.5 ~ 5.5V Please refer to the Function Manual			
	WORKING TEMP.	-30 ~ +70°C (Refer to "Derating Curve")			
	WORKING HUMIDITY	20 ~ 90% RH non-condensing			
	STORAGE TEMP., HUMIDITY	-40 ~ +85°C, 10 ~ 95% RH non-condensing			
TEMP. COEFFICIENT	±0.03%/°C (0 ~ 50°C)				
VIBRATION	10 ~ 500Hz, 2G 10min./1cycle, 60min. each along X, Y, Z axes				

SAFETY & EMC (Note.7)	<b>SAFETY STANDARDS</b>	UL62368-1, CAN/CSA C22.2 No. 62368-1, TUV BS EN/EN62368-1, EAC TP TC 004 approved		
	<b>WITHSTAND VOLTAGE</b> Note.4	I/P-O/P:3.75KVAC I/P-FG:2KVAC O/P-FG:1.25KVAC		
	<b>ISOLATION RESISTANCE</b> Note.4	I/P-O/P, I/P-FG, O/P-FG:100M Ohms / 500VDC / 25°C / 70% RH		
	<b>EMC EMISSION</b>	<b>Parameter</b>	<b>Standard</b>	<b>Test Level / Note</b>
		Conducted	BS EN/EN55032 (CISPR32) / EN55011 (CISPR11)	Class A
		Radiated	BS EN/EN55032 (CISPR32) / EN55011 (CISPR11)	Class A
		Harmonic Current	BS EN/EN61000-3-2	-----
		Voltage Flicker	BS EN/EN61000-3-3	-----
	<b>EMC IMMUNITY</b>	EN55024 , EN61204-3, EN61000-6-2		
		<b>Parameter</b>	<b>Standard</b>	<b>Test Level / Note</b>
ESD		BS EN/EN61000-4-2	Level 3, 8KV air ; Level 2, 4KV contact	
Radiated		BS EN/EN61000-4-3	Level 3	
EFT / Burst		BS EN/EN61000-4-4	Level 3	
Surge		BS EN/EN61000-4-5	Level 4, 4KV/Line-Earth ; Level 3, 2KV/Line-Line	
Conducted		BS EN/EN61000-4-6	Level 3	
Magnetic Field		BS EN/EN61000-4-8	Level 4	
Voltage Dips and Interruptions	BS EN/EN61000-4-11	>95% dip 0.5 periods, 30% dip 25 periods, >95% interruptions 250 periods		
<b>MTBF</b>	281.2K hrs min. Telcordia SR-332 (Bellcore) ; 28K hrs min. MIL-HDBK-217F (25°C)			
<b>DIMENSION</b>	SHP-10K: 460*211*83.5mm (L*W*H) SHP-10K-L: 460*216*83.5mm (L*W*H)			
<b>PACKING</b>	SHP-10K: 11.9Kg; 1pcs/11.9Kg/1.25CUFT SHP-10K-L: 11.9Kg; 1pcs/11.9Kg/1.1CUFT			
<b>NOTE</b>	<p>1. All parameters NOT specially mentioned are measured at 400VAC input, rated load and 25°C of ambient temperature.</p> <p>2. Ripple &amp; noise are measured at 20Mhz of bandwidth by using a 12" twisted pair-wire terminated with a 0.1uf &amp; 47uf parallel capacitor.</p> <p>3. Tolerance includes set up tolerance, line regulation and load regulation.</p> <p>4. During withstand voltage and isolation resistance testing, the screw "A" shall be temporarily removed, and shall be installed back after the testing.</p> <p>5. Derating may be needed under low input voltages. Please check the derating curve for more details.</p> <p>6. The efficiency is measured at 480VAC input.</p> <p>7. The power supply is considered a component which will be installed into a final equipment. All the EMC tests are executed by mounting the unit on a 600mm*900mm metal plate with 1mm of thickness. The final equipment must be re-confirmed that it still meets EMC directives. For guidance on how to perform these EMC tests, please refer to "EMI testing of component power supplies." <a href="https://www.meanwell.com/Upload/PDF/EMI_statement_en.pdf">https://www.meanwell.com/Upload/PDF/EMI_statement_en.pdf</a></p> <p>8. The ambient temperature derating of 3.5°C/1000m with fanless models and of 5°C/1000m with fan models for operating altitude higher than 2000m (6500ft).</p> <p>9. If use PV signal to adjust Vo, under certain operations conditions, ripple noise of Vo might slightly go over rating defined in this specification.</p> <p>10. Under light load condition, output voltage ripple will exceed specification. The behavior can be minimized by increasing the load.</p> <p>※ Product Liability Disclaimer : For detailed information, please refer to <a href="https://www.meanwell.com/serviceDisclaimer.aspx">https://www.meanwell.com/serviceDisclaimer.aspx</a></p>			

## 2.4 Derating curve

Blank Type:

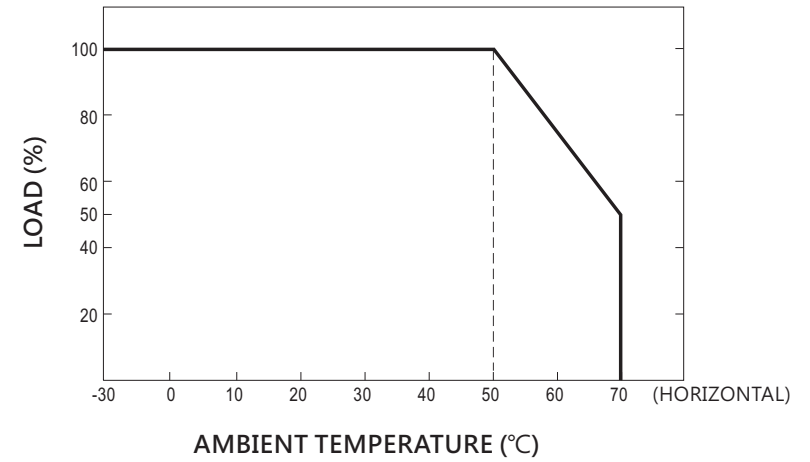

L Type:

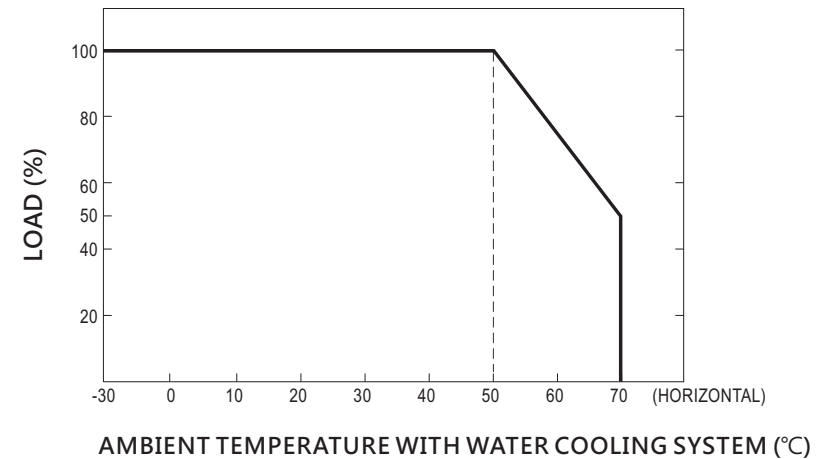

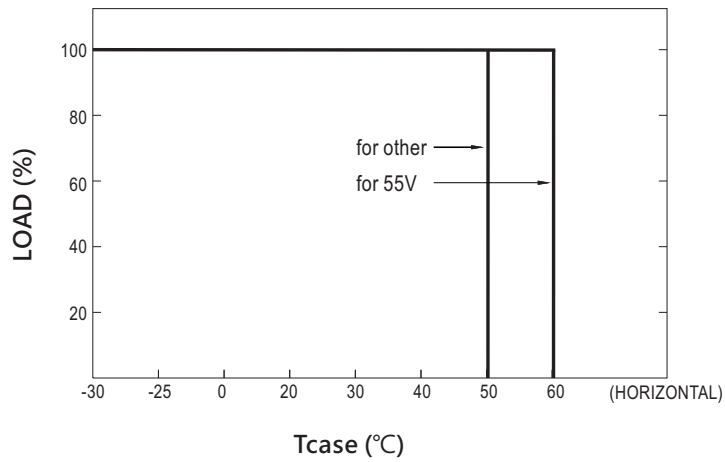
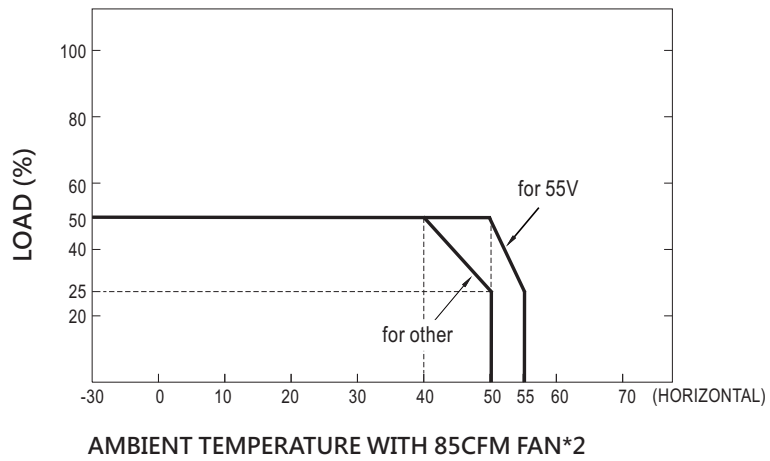

## 2.5 Mechanical specification

Forced-Air Cooling (Blank type)

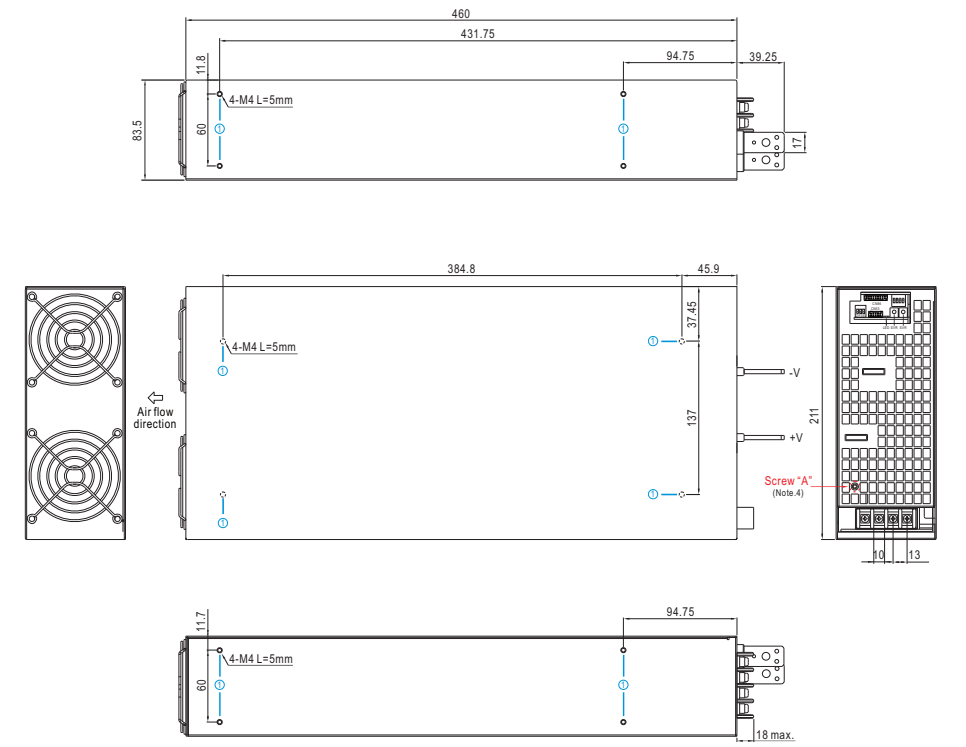

※ Mounting Instruction

Hole No.	Recommended Screw Size	MAX. Penetration Depth L	Recommended mounting torque
①	M4	5mm	7~10Kgf-cm

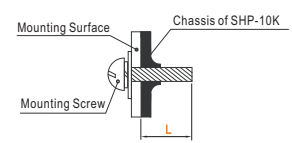

### Water Cooling (L type)

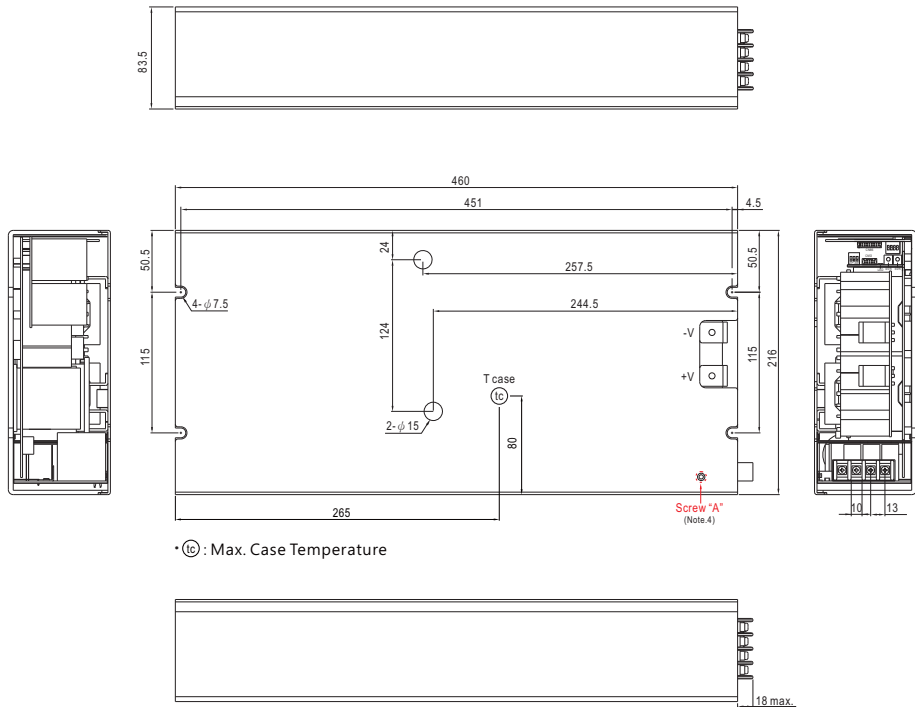

⊙ : Max. Case Temperature

## 3.Installation & Wiring

### 3.1 Mounting

#### 3.1.1 Normal Mounting

The Blank type is suggested mounting on horizontal surfaces.



Horizontal mounting

#### 3.1.2 Mounting on a Water Cooled Plate

A.L type with a water cooled plate for heat dissipation, it is suggested mount the supply onto a cooled plate made by MAENWELL, the PGG1WHS-684. All connecting surfaces between the supply and the plate have to apply thermal grease evenly before mounting.

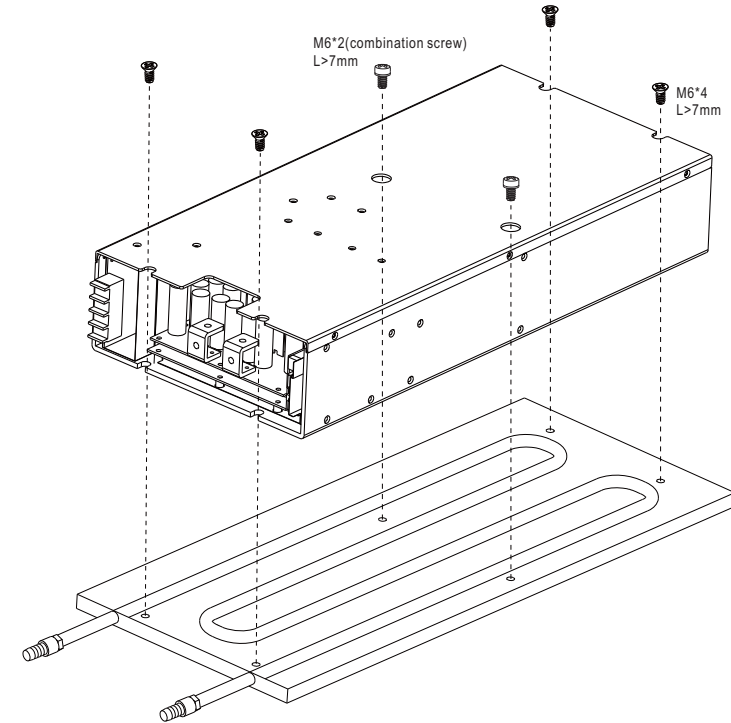



B. Recommended settings for cooling water operating parameters.

Ambient temperature: 50°C

Inlet temperature: 5~15°C

Flow rate (minimum): 4~ 10LPM

Humidity: 20~90% RH non-condensing

Pressure drop 6 psi (minimum), pressure inlet 80 psi (maximum)

C. Condensation - Safe operating area.

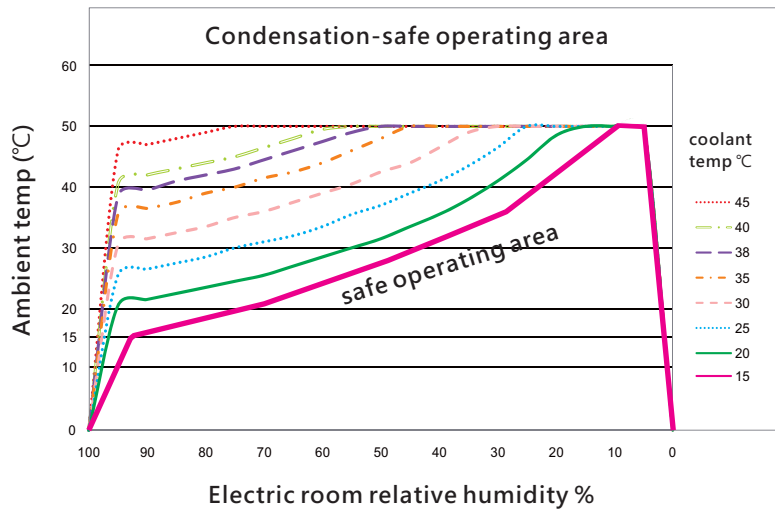

### 3.1.3 With 85CFM forced air

L type with a 85CFM forced air fan for heat dissipation, it is suggested mounting on horizontal surfaces as below.

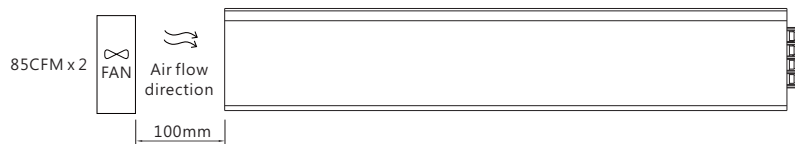

## 3.2 Installation Notes

A. Before any installation or maintenance work, please disconnect your system from the utility. Ensure that it cannot be re-connected inadvertently.

B. Keep enough insulation distance between mounting screws and internal components of power supplies. Please refer to 2.5 Mechanical specification to receive the maximum length of mounting screw

C. Mounting methods other than chapter 3.1 or operate under high ambient temperature may increase the internal component temperature and will require a de-rating in output current.

D. Fans and ventilation holes must be kept free from any obstructions. Also a 10-15 cm clearance must be kept when the adjacent device is a heat source.

## 3.3 Cable Size Selection

Cable connections should be as short as possible and make sure that suitable cables are chosen based on safety requirement and rating of current. Small cross section will result in lower efficiency, less output power and the cables may also become overheated and cause danger. For selection, please refer to table 3-1.

Table 3-1 cable recommendations

AWG	18	16	14	12	10	8	6	4	2
Suggest current (Amp)	6A	6-10A	10-16A	16-25A	25-32A	32-40A	40-63A	63-80A	80-100A
Cross-section of lead(mm <sup>2</sup> )	0.75	1.00	1.5	2.5	4	6	10	16	25

Note: Current each wire carries should be de-rated to 80% of the current

Make sure that all strands of each stranded wire enter the terminal connection and the screw terminals are securely fixed to prevent poor contact.

### 3.4 AC Power Connection

◎ 3φ3-wire / △ 340VAC~530VAC

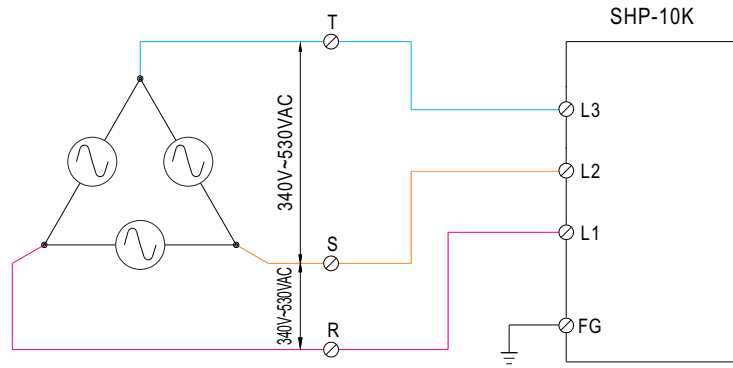

Figure 1

◎ 3φ3-wire / Y 340VAC~530VAC

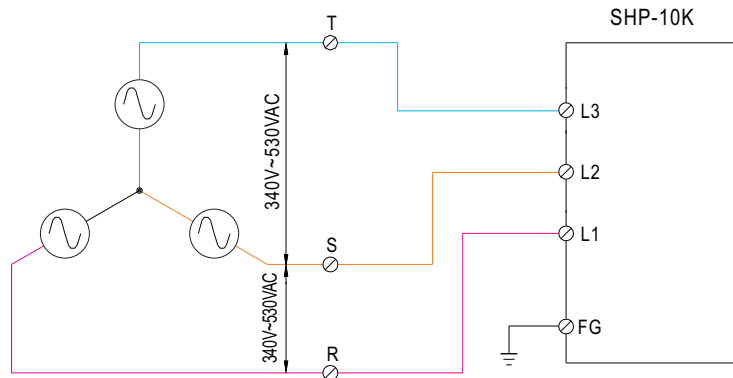

Figure 2

### 4. Panel and LED Indicator

#### 4.1 Blank type

##### 4.1.1 Panel Description

- Ⓐ AC input terminals
- Ⓑ DC output terminals
- Ⓒ DIP-SW1:  
Used for parallel control/PV/PC functions
- Ⓓ Function pins:  
They are used for control and monitoring functions. Please refer to 4.1.2 and 4.1.3.
- Ⓔ LED indicator:  
Indicate the status of the supply and load condition.
- Ⓕ SVRs:  
Used to adjust output voltage. The one on the top for fine-tune, the other for coarse-tune.
- Ⓖ DIP-SW81:  
Position 1~3 are for device addressing when using communication interface.  
Position 4 is an internal termination resistor that prevents signal rebound for differential signals of CAN bus and Modbus.

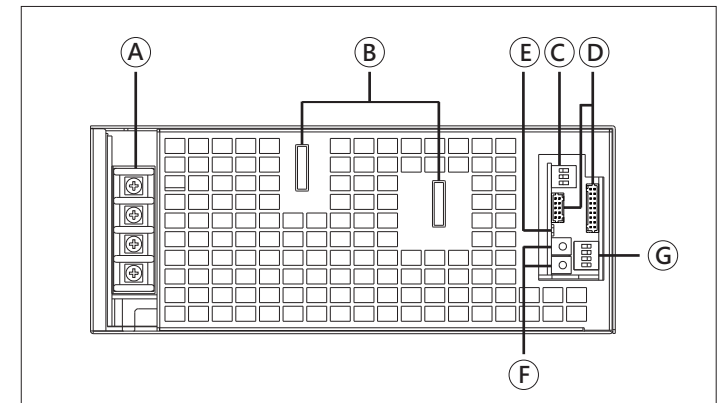

### 4.1.2 Pin Assignment of CN53

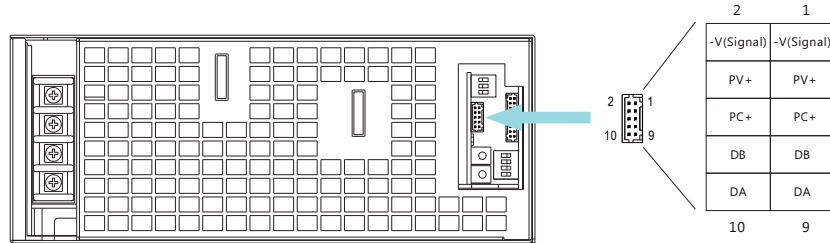

Pin No.	Function	Description
1,2	-V(Signal)	Negative output voltage signal. It is for local sense and certain function reference; it cannot be connected directly to the load.
3,4	PV+	Connection for output voltage programming. (Note)
5,6	PC+	Connection for constant current level programming. (Note)
7,8	DB	Differential digital signal for parallel control. (Note)
9,10	DA	

Note: Non-isolated signal, referenced to [-V(Signal)].

### 4.1.3 Pin Assignment of CN86

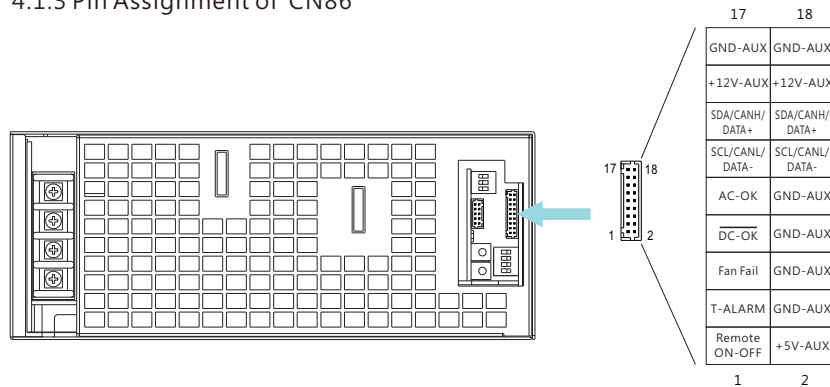

Pin No.	Function	Description
1	Remote ON-OFF	The unit can turn the output ON/OFF by dry contact between Remote ON/OFF and +5-AUX.(Note) Short (4.5 ~ 5.5V) : Power ON ; Open(0 ~ 0.5V) : Power OFF ; The maximum input voltage is 5.5V
2	+5V-AUX	Auxiliary voltage output, 4.5~5.5V, referenced to GND-AUX (pin 4,6,8,10,17,18) only for Remote ON/OFF used. This output is not controlled by the Remote ON/OFF control.
3	T-ALARM	High (3.5 ~ 5.5V) : When the internal temperature exceeds the limit of temperature alarm. Low (-0.5 ~ 0.5V) : When the internal temperature is normal. The maximum sourcing current is 10mA and only for output.(Note)
4,6,8,10	GND-AUX	Auxiliary voltage output GND. The signal return is isolated from the output terminals (+V & -V).
5	Fan Fail	High(3.5~5.5V):When the fan fail. Low(-0.5~0.5V):When the fan works normally. The maximum sourcing current is 10mA and only for output.(Note)
7	DC OK	High(3.5 ~ 5.5V) : When $V_{out} \leq 80\% \pm 6\%$ . Low(-0.5 ~ 0.5V) : When $V_{out} \geq 80\% \pm 6\%$ . The maximum sourcing current is 10mA and only for output.(Note)
9	AC OK	High (3.5 ~ 5.5V): When AC input $\geq 335 \pm 1.5\% V_{ac}$ , PSU works normally. Low (-0.5 ~ 0.5V): When AC input $\leq 320 \pm 1.5\% V_{ac}$ , PSU shut down. The maximum sourcing current is 10mA and only for output.(Note)
11,12	SCL	For PMBus model: Serial Clock used in the PMBus interface.(Note)
	CANL	For CANBus model: Data line used in CANBus interface.(Note)
	DATA-	For MODBus model: Data line used in MODBus interface.(Note)
13,14	SDA	For PMBus model: Serial Clock used in the PMBus interface.(Note)
	CANH	For CANBus model: Data line used in CANBus interface.(Note)
	DATA+	For MODBus model: Data line used in MODBus interface.(Note)
15,16	+12V-AUX	Auxiliary voltage output, 11.4~12.6V, referenced to GND-AUX (pin17 & 18). The maximum load current is 1A. This output is not controlled by "Remote ON-OFF" .
17,18	GND-AUX	Auxiliary voltage output GND. The signal return is isolated from the output terminals(+V & -V).

Note: Isolated signal, referenced to (GND-AUX).

## 4.2 L type

### 4.2.1 Panel Description

- (A) AC input terminals**
- (B) DC output terminals**
- (C) DIP-SW1:**  
Used for parallel control/PV/PC functions
- (D) Function pins:**  
They are used for control and monitoring functions. Please refer to 4.2.2 and 4.2.3.
- (E) LED indicator:**  
Indicate the status of the supply and load condition.
- (F) SVRs:**  
Used to adjust output voltage. The one on the top for fine-tune, the other for coarse-tune.
- (G) DIP-SW81:**  
Position 1~3 are for device addressing when using communication interface.  
Position 4 is an internal termination resistor that prevents signal rebound for differential signals of CAN bus and Modbus.

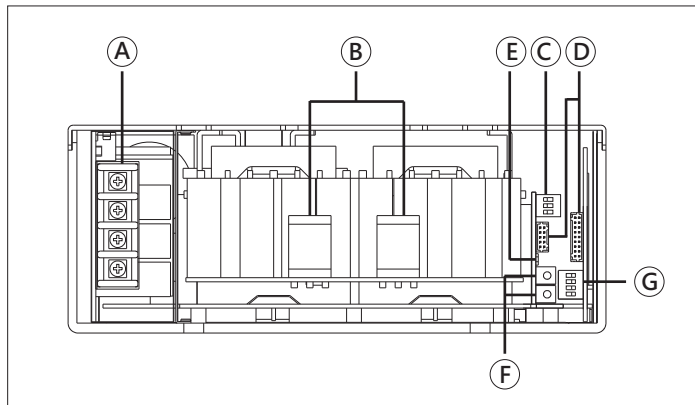

### 4.2.2 Pin Assignment of CN53

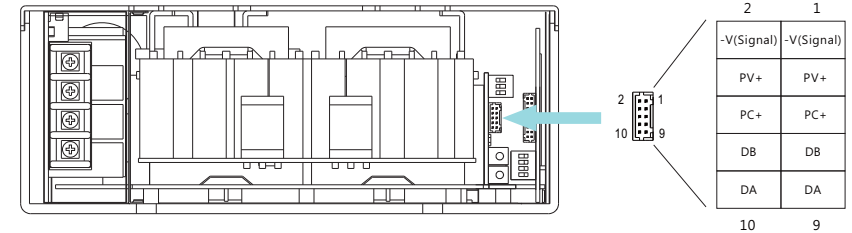

Pin No.	Function	Description
1,2	-V(Signal)	Negative output voltage signal. It is for local sense and certain function reference; it cannot be connected directly to the load.
3,4	PV+	Connection for output voltage programming. (Note)
5,6	PC+	Connection for constant current level programming. (Note)
7,8	DB	Differential digital signal for parallel control. (Note)
9,10	DA	

Note: Non-isolated signal, referenced to [-V(Signal)].

### 4.2.3 Pin Assignment of CN86

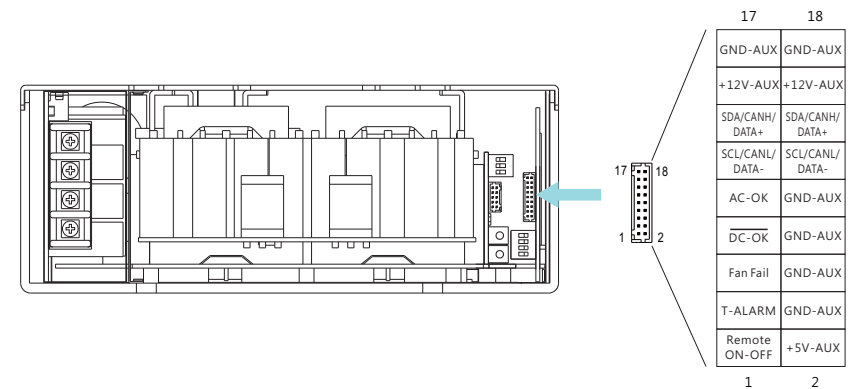

Pin No.	Function	Description
1	Remote ON-OFF	The unit can turn the output ON/OFF by dry contact between Remote ON/OFF and +5-AUX.(Note) Short (4.5 ~ 5.5V) : Power ON ; Open(0 ~ 0.5V) : Power OFF ; The maximum input voltage is 5.5V
2	+5V-AUX	Auxiliary voltage output, 4.5~5.5V, referenced to GND-AUX (pin 4,6,8,10,17,18) only for Remote ON/OFF used. This output is not controlled by the Remote ON/OFF control.
3	T-ALARM	High (3.5 ~ 5.5V) : When the internal temperature exceeds the limit of temperature alarm. Low (-0.5 ~ 0.5V) : When the internal temperature is normal. The maximum sourcing current is 10mA and only for output.(Note)
4,6,8,10	GND-AUX	Auxiliary voltage output GND. The signal return is isolated from the output terminals (+V & -V).
5	Fan Fail	High(3.5~5.5V):When the fan fail. Low(-0.5~0.5V):When the fan works normally. The maximum sourcing current is 10mA and only for output.(Note)
7	DC OK	High(3.5 ~ 5.5V) : When $V_{out} \leq 80\% \pm 6\%$ . Low(-0.5 ~ 0.5V) : When $V_{out} \geq 80\% \pm 6\%$ . The maximum sourcing current is 10mA and only for output.(Note)
9	AC OK	High (3.5 ~ 5.5V): When AC input $\geq 335 \pm 1.5\% V_{ac}$ , PSU works normally. Low (-0.5 ~ 0.5V): When AC input $\leq 320 \pm 1.5\% V_{ac}$ , PSU shut down. The maximum sourcing current is 10mA and only for output.(Note)
11,12	SCL	For PMBus model: Serial Clock used in the PMBus interface.(Note)
	CANL	For CANBus model: Data line used in CANBus interface.(Note)
	DATA-	For MODBus model: Data line used in MODBus interface.(Note)
13,14	SDA	For PMBus model: Serial Clock used in the PMBus interface.(Note)
	CANH	For CANBus model: Data line used in CANBus interface.(Note)
	DATA+	For MODBus model: Data line used in MODBus interface.(Note)
15,16	+12V-AUX	Auxiliary voltage output, 11.4~12.6V, referenced to GND-AUX (pin17 & 18). The maximum load current is 1A. This output is not controlled by "Remote ON-OFF" .
17,18	GND-AUX	Auxiliary voltage output GND. The signal return is isolated from the output terminals(+V & -V).

Note: Isolated signal, referenced to (GND-AUX).

## 5.Operation

### 5.1 Inrush Current Limiting

- Built-in AC inrush current limiting circuit.
- Since the inrush current limiting circuit mainly consists of a NTC thermistor and a relay, inrush current will be much higher than the specified value if the thermistor is not allowed sufficient time to cool down. After turning off the supply, a 10 second cool down period is recommended before turning on again.

### 5.2 Power Factor Correction (PFC)

- Built-in active power factor correction (PFC) function, power factor (PF) will be 0.98 or better at full load condition. PF will be less than 0.98 if it is not at full load condition.

### 5.3 Output Voltage Adjustment

- Output voltage can be adjusted via SVR, PV or communication interface.

#### 5.3.1 SVR

A. Have the DIP switch position-3 set as

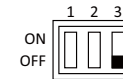

B. Output voltage can be trimmed by the SVRs. The one on the top for fine-tune, the other for coarse-tune, please refer to illustration below.

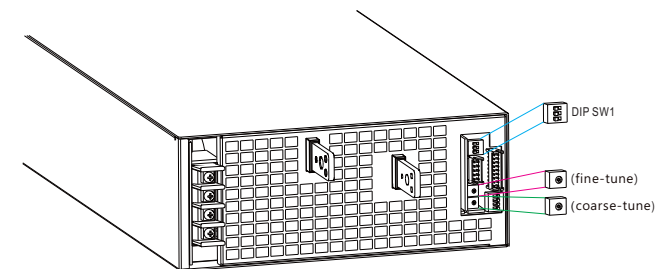
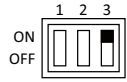

Figure 5-1

### 5.3.2 PV (Output Voltage Programming)

A. Have the DIP switch position-3 set as



B. Connect output of the external DC source to PV+ and -V(signal), as shown in Figure 5-2.

C. Relationship between output voltage and external DC source is shown in Figure 5-3.

D. When increasing the output to a higher voltage level, please reduce the loading current accordingly. Output wattage of the unit should not exceed the rated value under any circumstance.

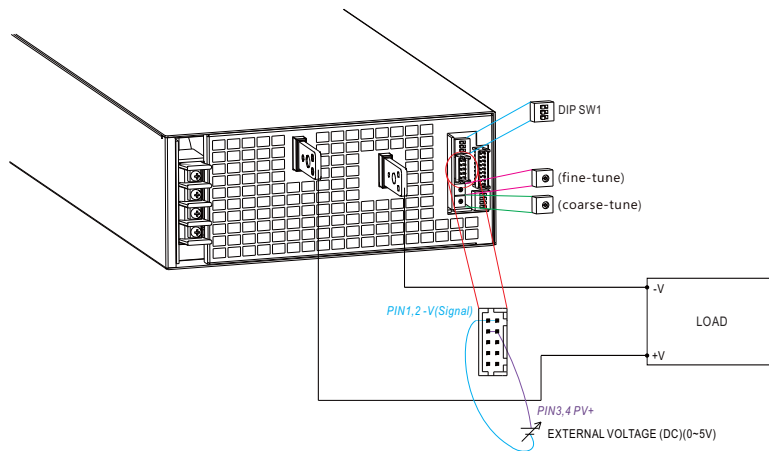

Figure 5-2

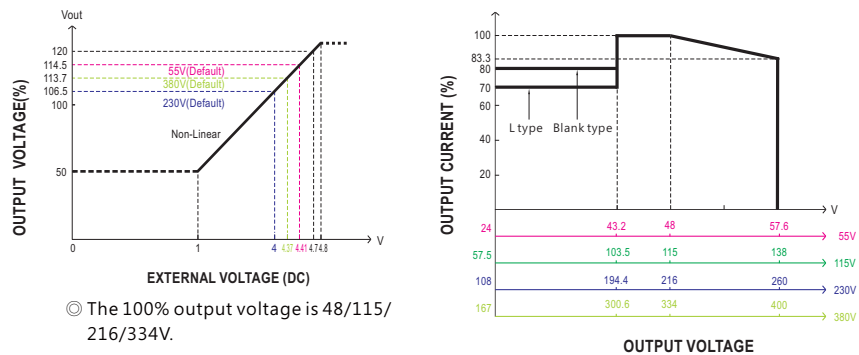

Figure 5-3

### 5.3.3 Communication

Output voltage can be adjusted through communication interfaces: PMBus, CAN bus or Modbus. Please refer to chapter 6 for detailed information.

## 5.4 Output Current Adjustment

- Output current can be adjusted via PC and communication interface.

### 5.4.1 PC (Output Current Programming)

A. Default setting is at Overload Protection (OLP) value



B. To enable Constant Current Level Programming, have the DIP switch position-2 set as

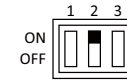

C. Connect output of the external DC source to PC+ and -V(signal), as shown in Figure 5-4.

D. Relationship between output current and external DC source I shown in Figure 5-5.

E. Covered by over temperature protection, auto de-rating function works under operation either in PC mode or under control by communication protocol.

T1(Typ.): Maximum ambient temperature of full load  
T2(Typ.): T1+5°C

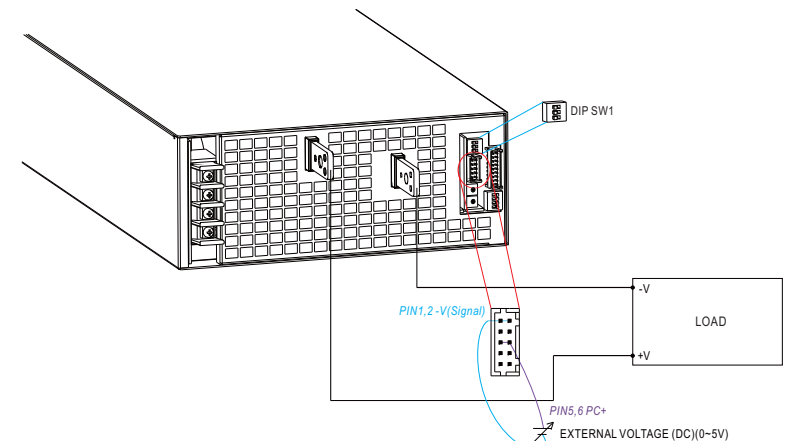
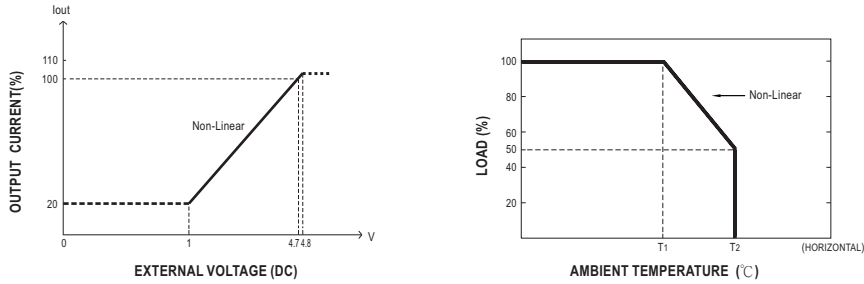

Figure 5-4



© The 100% output current is 150/87/46.3/30A.

Figure 5-5

### 5.5 Parallel function

#### 5.5.1 DA, DB signal and parallel control function

##### (1) Non-parallel operation

A. Set the DIP switch of position-1 as

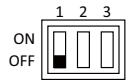

B. By default, non-parallel operation

##### (2) Default Parallel operation

A. Set the DIP switch of position-1 as

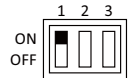

B. PSUs are configured in parallel operation

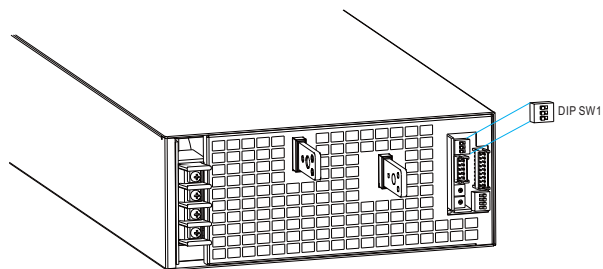

Figure 5-6

#### 5.5.2

SHP-10K has the built-in active current sharing function and can be connected in parallel, up to 4 units, to provide higher output power as exhibited below :

- ◎ The power supplies should be paralleled using short and large diameter wiring and then connected to the load.
- ◎ In parallel connection, power supply with the highest output Voltage will be the master unit and its Vout will be the DC bus voltage.
- ◎ The total output current must not exceed the value determined by the following equation:  
Maximum output current at parallel operation = (Rated current per unit) × (Number of unit) × 0.95
- ◎ When the total output current is less than 5% of the total rated current, or say (5% of Rated current per unit) × (Number of unit) the current shared among units may not be balanced.
- ◎ Under parallel operation ripple of the output voltage may be higher than the SPEC at light load condition. It will go back to normal ripple level once the output load is more than 5%.

##### ◎ CN53/SW1 Function pin connection

Parallel	PSU1		PSU2		PSU3		PSU4	
	CN53	SW1 PIN1	CN53	SW1 PIN1	CN53	SW1 PIN1	CN53	SW1 PIN1
1 unit	X	ON	—	—	—	—	—	—
2 unit	V	ON	V	ON	—	—	—	—
3 unit	V	ON	V	OFF	V	ON	—	—
4 unit	V	ON	V	OFF	V	OFF	V	ON

(V : CN53 connected ; X : CN53 not connected.)

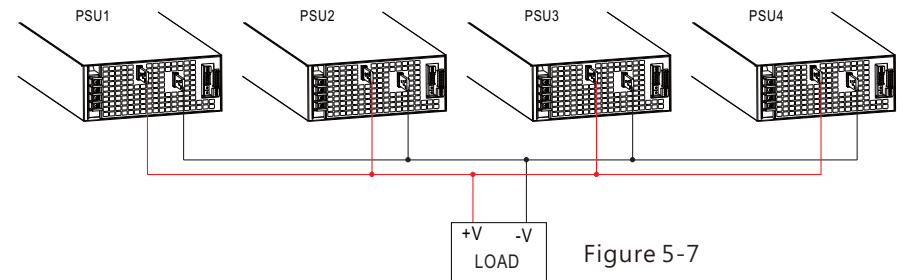
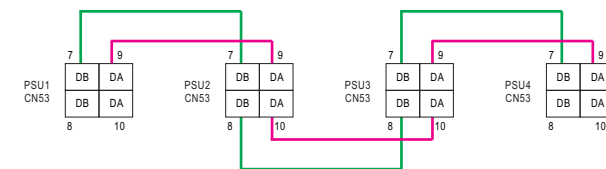

Figure 5-7



If the lines of CN53 are too long, they should be twisted in pairs to avoid the noise

- ◎ DA, DB are connected mutually in parallel

## 5.6 Remote Control

- The power supply can be turned ON-OFF by using the "Remote ON-OFF" function.

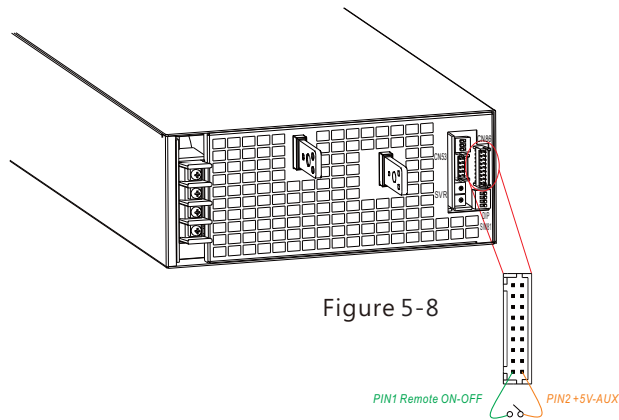

Figure 5-8

Remote ON-OFF(CN86 pin1) to 5V-AUX(CN86 pin2)	Status
Short	power supply ON
Open	power supply OFF

## 5.7 Alarm Signal Output

- There are 4 alarm signals, DC-OK, T-ALARM, Fan Fail and AC-OK, in TTL signal form, on CN86. These signals are isolated from output.

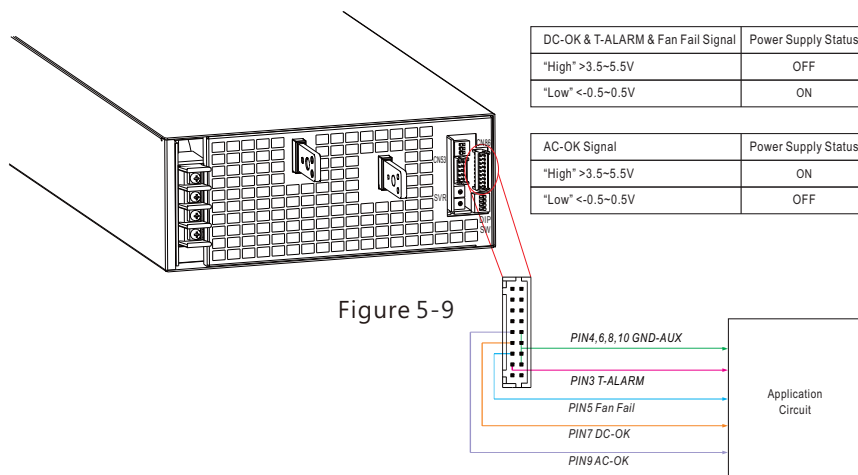

Figure 5-9

DC-OK & T-ALARM & Fan Fail Signal	Power Supply Status
"High" >3.5-5.5V	OFF
"Low" <-0.5-0.5V	ON

AC-OK Signal	Power Supply Status
"High" >3.5-5.5V	ON
"Low" <-0.5-0.5V	OFF

## 5.8 Auxiliary Output

- Built-in 12V/1A auxiliary output

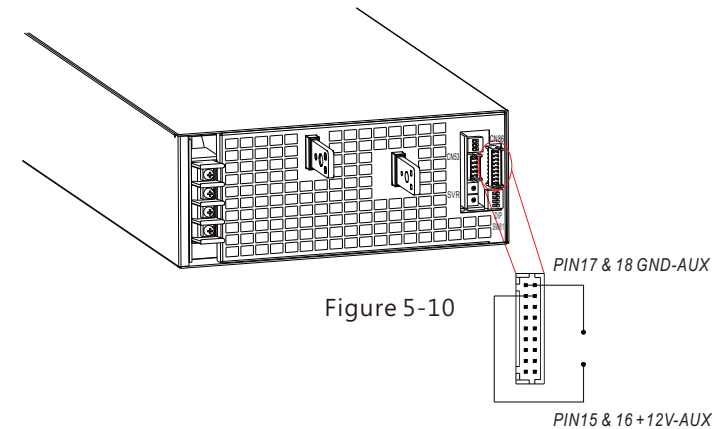

Figure 5-10

+12V-AUX to GND-AUX	12Vdc
---------------------	-------

## 5.9 Factory Resetting

- Users can follow the steps below to restore factory settings for commands: VOUT\_TRIM(VOUT\_SET), IOU\_OC\_FAULT\_LIMIT(IOU\_SET), OPERATION, SYSTEM\_CONFIG and all charge commands  
DIP switch diagram is as shown below.

- Set all DIP switch positions to ON.
- Power on in REMOTE OFF mode (no output at this step).
- After power on, in 15 seconds, switch all DIP switch from ON to OFF and then switch ALL back to ON position.
- Green LED will blink 3 times if set successfully.
- Factory default setting will be restored after re-power on.

DIP switch diagram is as shown below.





## 6. Communication Protocol

- There are two means to control the unit, analog signals and digital communication. Analog is the default setting for the unit, signals including PV, PC and SVR can be used immediately once receiving the unit. The digital communication (PMBus, CAN bus or Modbus) is initially uncontrollable but readable. To activate the adjustment commands of OPERATRION, VOUT\_TRIM or VOUT\_SET., ect., set PM\_CTRL/CAN\_CTRL/MOD\_CTRL of SYSTEM\_CONFIG (PMBus: BEh; CAN bus: 0x00C2; Modbus: 0x00C4) at "1" and then reboot the unit. Once the digital communication dominates the unit, the analog signals become invalid.

### 6.1 PMBus Communication Interface

- SHP-10K is compliant with PMBus Rev.1.1, the maximum communication speed is 100KHz and has the capability of identifying up to 4 addressed units.
- PMBus communication interface is able to provide the current operating status and information. Supported information is as below:
  - Output voltage, current and internal temperature
  - Alarm and status.
  - Manufacturer and mode data.

#### 6.1.1 PMBus Device Addressing

Each SHP-10K unit should have their unique and own device address to communicate over the PMBus. 7-bit address setting is used to assign advice address, shown in the description below

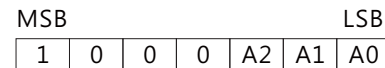

A0-A2 allow users to designate an address for the SHP-10K unit, these three bits are defined through a DIP switch (DIP-SW81) on the side case. There are up to 8 different addresses are available to be assigned. Please refer to Table 6-1 for the detailed setup advice.



Device No.	DIP switch position		
	1	2	3
0	ON	ON	ON
1	OFF	ON	ON
2	ON	OFF	ON
3	OFF	OFF	ON
4	ON	ON	OFF
5	OFF	ON	OFF
6	ON	OFF	OFF
7	OFF	OFF	OFF

Table 6-1

### 6.1.2 PMBus Command List

- The command list of the SHP-10K is shown in Table 6-2. It is compliant with the standard protocol of PMBus Rev. 1.1. For detailed information, please refer to PMBus official website (<http://pmbus.org/specs.html>).

Table 6-2

Command Code	Command Name	Page	Transaction Type	# of data Bytes	Description
00h	PAGE	All	R/W Byte	1	Page
01h	OPERATION	All	R/W Byte	1	Remote ON/OFF control
02h	ON_OFF_CONFIG	All	Read Byte	1	ON/OFF function configuration
19h	CAPABILITY	All	Read Byte	1	Capabilities of a PMBus device
20h	VOUT_MODE	All	Read Byte	1	Define data format for output voltage (format: linear, N= -6)
21h	VOUT_COMMAND	All	R/W Word	2	Define data format for output voltage
22h	VOUT_TRIM*	All	R/W Word	2	Output voltage trimmed value
46h	IOUT_OC_FAULT_LIMIT*	All	R/W Word	2	Output overcurrent setting value (format: linear, N= -2)
47h	IOUT_OC_FAULT_RESPONSE	All	Read Byte	1	Define protection and response when an output overcurrent fault occurred
79h	STATUS_WORD	All	Read Word	2	Summary status reporting
7Ah	STATUS_VOUT	All	Read Byte	1	Output voltage status reporting
7Bh	STATUS_IOUT	All	Read Byte	1	Output current status reporting
7Ch	STATUS_INPUT	All	Read Byte	1	AC input voltage status reporting
7Dh	STATUS_TEMPERATURE	All	Read Byte	1	Temperature status reporting
7Eh	STATUS_CML	All	Read Byte	1	Communication, logic, Memory status reporting
80h	STATUS_MFR_SPECIFIC	All	Read Byte	1	Manufacture specific status reporting
81h	STATUS_FANS_1_2	All	Read Byte	1	Fan1 and 2 status reporting
88h	READ_VIN	0	Read Word	2	V <sub>88</sub> input voltage reading value (format: linear, N=0)
88h	READ_VIN	1	Read Word	2	V <sub>81</sub> input voltage reading value (format: linear, N=0)
88h	READ_VIN	2	Read Word	2	V <sub>8</sub> input voltage reading value (format: linear, N=0)
89h	READ_IIN	0	Read Word	2	R input current reading value (format: linear, N=-5)
89h	READ_IIN	1	Read Word	2	S input current reading value (format: linear, N=-5)
89h	READ_IIN	2	Read Word	2	T input current reading value (format: linear, N=-5)
8Bh	READ_VOUT	All	Read Word	2	Output voltage reading value (format: linear, N= -6)
8Ch	READ_IOUT	All	Read Word	2	Output current reading value (SHP-10K: format: linear, N= -2)
8Dh	READ_TEMPERATURE_1	All	Read Word	2	Temperature 1 reading value (format: linear, N= -3)
90h	READ_FAN_SPEED_1	All	Read Word	2	Fan speed 1 reading value
91h	READ_FAN_SPEED_2	All	Read Word	2	Fan speed 2 reading value
98h	PMBUS_REVISION	All	Read Byte	1	The compliant revision of the PMBus
99h	MFR_ID	All	Block Read	12	Manufacturer's name
9Ah	MFR_MODEL	All	Block Read	12	Manufacturer's model name
9Bh	MFR_REVISION	All	Block Read	24	Firmware revision
9Ch	MFR_LOCATION	All	Block R/W	3	Manufacturer's factory location
9Dh	MFR_DATE	All	Block R/W	6	Manufacture date
9Eh	MFR_SERIAL	All	Block R/W	12	Product serial number
BEh	SYSTEM_CONFIG	All	R/W Word	2	System setting
BFh	SYSTEM_STATUS	All	Read Word	2	System status

Note: Setting commands with \* at the end support the EEP\_OFF and EEP\_CONFIG functions. For detailed information on how to enable them, please refer to SYSTEM\_CONFIG (BEh).

© Definition of Command BEh SYSTEM\_CONFIG :

	Bit7	Bit6	Bit5	Bit4	Bit3	Bit2	Bit1	Bit0
High byte	-	-	-	-	-	EEP_OFF	EEP_CONFIG	
Low byte	-	-	-	-	-	OPERATION_INIT		PM_CTRL

Low byte

Bit 0 PM\_CTRL: PMBus Control Selection

0 = Output voltage and current controlled by SVR/PV/PC (factory default)

1 = Output voltage, current and remote ON/OFF controlled by PMBus  
(VOUT\_TRIM \ IOUT\_FAULT\_LIMIT \ OPERATION)

Bit 1: 2 OPERATION\_INIT : OPERATION\_INIT : Initial Operational Behavior

0b00 = Power on with 0x00: OFF

0b01 = Power on with 0x80: ON (factory default)

0b10 = Power on with the last setting

0b11 = Not used

High Byte:

Bit 0:1 EEP\_CONFIG EEPROM Configuration

00: Immediate. Changes to parameters are written to EEPROM immediately (factory default)

01: 1 minute delay. Write changes to EEPROM if all parameters remain unchanged for 1 minute

10: 10 minute delay. Write changes to EEPROM if all parameters remain unchanged for 10 minutes

11: Reserved

Bit 2 EEP\_OFF:EEPROM storage function ON/OFF

0: Enable. Parameters to be saved into EEPROM (factory default)

1: Disable. Parameters NOT to be saved into EEPROM

Note: Unsupported settings display with "0"

© Definition of Command BFh SYSTEM\_STATUS:

	Bit7	Bit6	Bit5	Bit4	Bit3	Bit2	Bit1	Bit0
High byte	-	-	-	-	-	-	-	-
Low byte	-	EEPER	INITIAL_STATE	ADL_ON	-	PFC_OK	DC_OK	M/S

Low byte

Bit 0: M/S : Parallel mode status

0 = Current device is Slave

1 = Current device is Master

Bit 1: DC\_OK : Secondary DD output voltage status

0 = Secondary DD output voltage status TOO LOW

1 = Secondary DD output voltage status NORMAL

Bit 2: PFC\_OK : Primary PFC status

0 = Primary PFC OFF or abnormal

1 = Primary PFC ON normally

Bit 4 ADL\_ON : Active dummy load control status

0 = Active dummy load off

1 = Active dummy load on

Bit 5 INITIAL\_STATE : Device initialized status

0 = NOT in initialization status

1 = In initialization status

Bit 6 EEPER: EEPROM data access error

0 = EEPROM data access normal

1 = EEPROM data access error

Note:

1. When an EEPROM data access error occurs, the supply shuts down and then entering protection mode with the LED indicator off. It only can be recovered after the EEPROM error condition is resolved.

2. Unsupported settings display with "0"

6.1.3 Notes on PMBus

1. Insert a at least 50msec delay between commands.

2. Examples for Format Conversion:

(1) LINEAR16 format: VOUT\_COMMAND, VOUT\_TRIM, READ\_VOUT.

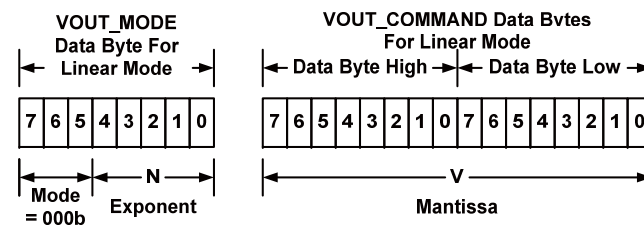

Linear Format Data Bytes

The Mode bits are set to 000b.

The Voltage, in volts, is calculated from the equation:

$$\text{Voltage} = V \cdot 2^N$$

Where:

Voltage is the parameter of interest in volts;

V is a 16 bit unsigned binary integer; and

N is a 5 bit two's complement binary integer.

For example:

Vo\_real (actual output voltage) =  $V \times 2^N$ , V is from READ\_VOUT.

If VOUT\_MODE = 0x17, meaning N is -9. READ\_VOUT is 0x3000 → 12288, then

$$\text{Vo\_real} = 12288 \times 2^{-9} = 24.0\text{V.}$$

(2) LINEAR11 format: IOUT\_OC\_FAULT\_LIMIT, READ\_VIN, READ\_IIN, READ\_IOUT, READ\_TEMPERATURE\_1, READ\_FAN\_SPEED\_1, READ\_FAN\_SPEED\_2.

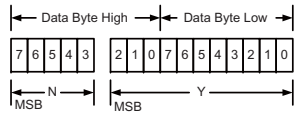

Linear Data Format Data Bytes Y, N and the "real world" value is:

The relation between

$$X = Y \cdot 2^N$$

Where, as described above:

X is the "real world" value;

Y is an 11 bit, two's complement integer; and

N is a 5 bit, two's complement integer.

Devices that use the Linear format must accept and be able to process any value of N.

For example:

$I_{o\_real}$  (actual output current) =  $Y \times 2^N$ , Y is from READ\_IOUT.

If READ\_IOUT is 0xF188, meaning N is -2 and Y is 0x0188. Y is 0x0188 → 392, then  $I_{o\_real} = 392 \times 2^{-2} = 98.0A$ .

● Data Field Format

Controller to SHP

Write:

Data field bytes

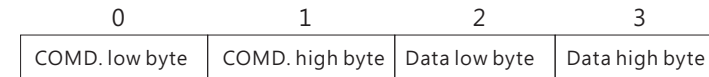

Read:

Data field bytes

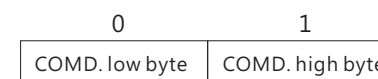

SHP to Controller:

Data field bytes



NOTE: SHP will not send data back when write parameters, such as VOUT\_SET

6.2.1 Message ID definition

Message ID	Description
0x000C00XX	SHP to Controller Message ID
0x000C01XX	Controller to SHP Message ID
0x000C01FF	Controller broadcasts toSHP Message ID

NOTE: XX means the address of SHP-10K ( which can be assigned by the DIP switch of DIP-SW81



Device No.	DIP switch position		
	1	2	3
0	ON	ON	ON
1	OFF	ON	ON
2	ON	OFF	ON
3	OFF	OFF	ON
4	ON	ON	OFF
5	OFF	ON	OFF
6	ON	OFF	OFF
7	OFF	OFF	OFF

Table 6-3

6.2 CANBus Communication Interface

● Physical layer specification

This protocol follows CAN ISO-11898 with Baud rate of 250Kbps.

● Data Frame

This protocol uses Extended CAN 29-bit identifier frame format or CAN 2.0B.

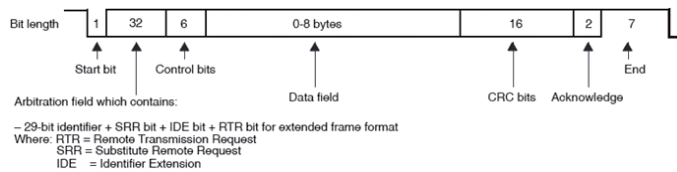

● Communication Timing

Min. request period (Controller to SHP-10K): 50mSec ◦

Max. response time (SHP-10K to Controller): 12.5mSec ◦

Min. packet margin time (Controller to SHP-10K): 12.5mSec ◦

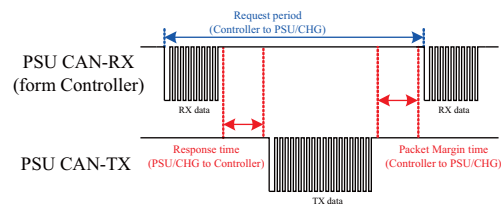

Table 6-4

Command Code	Command Name	Transaction Type	# of data Bytes	Description
0x0000	OPERATION	R/W	1	ON/OFF control ON: 01h/OFF: 00h
0x0020	VOUT_SET*	R/W	2	Output voltage set (format: value, F=0.01)
0x0030	IOUT_SET*	R/W	2	Output current set (format: value, F=0.01)
0x0040	FAULT_STATUS	R	2	Abnormal status
0x0050	READ_VIN_RS	R	2	$V_{RS}$ Input voltage read value (format: value, F=0.1)
0x0051	READ_VIN_ST	R	2	$V_{ST}$ Input voltage read value (format: value, F=0.1)
0x0052	READ_VIN_TR	R	2	$V_{TR}$ Input voltage read value (format: value, F=0.1)
0x0053	READ_IIN_R	R	2	R Input current read value (format: value, F=0.1)
0x0054	READ_IIN_S	R	2	S Input current read value (format: value, F=0.1)
0x0055	READ_IIN_T	R	2	T Input current read value (format: value, F=0.1)
0x0060	READ_VOUT	R	2	Output voltage read value (format: value, F=0.01)
0x0061	READ_IOUT	R	2	Output current read value (format: value, F=0.01)
0x0062	READ_TEMPERATURE_1	R	2	Internal ambient temperature (format: value, F=0.1)
0x0070	READ_FAN_SPEED_1	R	2	Fan speed 1 reading value (format: value, F=1)
0x0071	READ_FAN_SPEED_2	R	2	Fan speed 2 reading value (format: value, F=1)
0x0080	MFR_ID_B0B5	R	6	Manufacture's name
0x0081	MFR_ID_B6B11	R	6	Manufacture's name
0x0082	MFR_MODEL_B0B5	R	6	Manufacture model name
0x0083	MFR_MODEL_B6B11	R	6	Manufacture model name
0x0084	MFR_REVISION_B0B5	R	6	Firmware version
0x0085	MFR_LOCATION_B0B2	R	3	Manufacture place
0x0086	MFR_DATE_B0B5	R	6	Manufacture date
0x0087	MFR_SERIAL_B0B5	R	6	Manufacture serial number
0x0088	MFR_SERIAL_B6B11	R	6	Manufacture serial number
0x00C0	SCALING_FACTOR	R	6	Scaling ratio

Command Code	Command Name	Transaction Type	# of data Bytes	Description
0x00C1	SYSTEM_STATUS	R	2	System status
0x00C2	SYSTEM_CONFIG	R/W	2	System configuration

Note: Setting commands with \* at the end support the EEP\_OFF and EEP\_CONFIG functions. For detailed information on how to enable them, please refer to SYSTEM\_CONFIG (0x00C2).

#### Data conversion :

The conversion of setting and reading values is defined as following:  
Actual value = Communication reading value × F actor (F value). Among them, Factor needs to refer to the definition of SCALING\_FACTOR in each model list.

EX:  $V_{o\_real}$  (actual DC voltage) = READ\_VOUT × Factor.

If the Factor of READ\_VOUT of a certain model is 0.01, the communication reading value is 0x0960 (hexadecimal)→2400 (decimal), then  $VDC\_real = 2400 \times 0.01 = 24.00V$ .

#### ◎FAULT\_STATUS (0x0040):

	Bit7	Bit6	Bit5	Bit4	Bit3	Bit2	Bit1	Bit0
High byte	-	-	-	-	-	-	-	-
Low byte	HI_TEMP	OP_OFF	AC_FAIL	SHORT	OLP	OVP	OTP	FAN_FAIL

#### Low byte

Bit 0 FAN\_FAIL : Fan locked flag  
0 = Working normally  
1 = Fan locked

Bit 1 OTP : Over temperature protection  
0 = Internal temperature normal  
1 = Internal temperature abnormal

Bit 2 OVP : DC over voltage protection  
0 = DC voltage normal  
1 = DC over voltage protected

Bit 3 OLP : DC over current protection  
0 = DC current normal  
1 = DC over current protected

Bit 4 SHORT : Short circuit protection  
0 = Shorted circuit do not exist  
1 = Shorted circuit protected

Bit 5 AC\_FAIL : AC abnormal flag  
0 = AC input range normal  
1 = AC input range abnormal

Bit 6 OP\_OFF : DC status  
0 = DC output turned on  
1 = DC output turned off

Bit 7 HI\_TEMP : Internal high temperature protection  
 0 = Internal temperature normal  
 1 = Internal temperature abnormal

Note: Unsupported settings displays with "0"

©MFR\_ID\_B0B5 (0x0080) is the first 6 codes of the manufacturer's name (ASCII); MFR\_ID\_B6B11 (0x0081) is the last 6 codes of the manufacturer's name (ASCII)

EX: Manufacturer's name is MEANWELL → MFR\_ID\_B0B5 is MEANWE ; MFR\_ID\_B6B11 is LL

MFR_ID_B0B5					
Byte 0	Byte 1	Byte 2	Byte 3	Byte 4	Byte 5
0x4D	0x45	0x41	0x4E	0x57	0x45

MFR_ID_B6B11					
Byte 0	Byte 1	Byte 2	Byte 3	Byte 4	Byte 5
0x4C	0x4C	0x20	0x20	0x20	0x20

©MFR\_MODEL\_B0B5 (0x0082) is the first 6 codes of the manufacturer's model name(ASCII); MFR\_MODEL\_B6B11 (0x0083) is the last 6 codes of the manufacturer's model name (ASCII);

EX: Model name is SHP-10K-55 → MFR\_MODEL\_B0B5 is SHP-10 ; MFR\_MODEL\_B6B11 is K-55

MFR_MODEL_B0B5					
Byte 0	Byte 1	Byte 2	Byte 3	Byte 4	Byte 5
0x53	0x48	0x50	0x2D	0x31	0x30

MFR_ID_B6B11					
Byte 6	Byte 7	Byte 8	Byte 9	Byte 10	Byte 11
0x6B	0x2D	0x35	0x35	0x20	0x20

©MFR\_REVISION\_B0B5 (0x0084) is the firmware revision (hexadecimal). A range of 0x00 (R00.0)~0xFE (R25.4) represents the firmware version of an MCU; 0xFF represents no MCU existed.

EX: The supply has two MCUs, the firmware version of the MCU number 1 is version R25.4 (0xFE), the MCU number 2 is version R10.5 (0x69)

Byte 0	Byte 1	Byte 2	Byte 3	Byte 4	Byte 5
0xFE	0x69	0xFF	0xFF	0xFF	0xFF

©MFR\_DATE\_B0B5 (0x0086) is manufacture date (ASCII)

EX: MFR\_DATE\_B0B5 is 180101, meaning 2018/01/01

Byte 0	Byte 1	Byte 2	Byte 3	Byte 4	Byte 5
0x31	0x38	0x30	0x31	0x30	0x31

©MFR\_SERIAL\_B0B5 (0x0087) and MFR\_SERIAL\_B6B11 (0x0088) are defined as manufacture date and manufacture serial number (ASCII)

EX: The first unit manufactured on 2018/01/01 → MFR\_SERIAL\_B0B5: 180101 ; MFR\_SERIAL\_B6B11: 000001

Byte 0	Byte 1	Byte 2	Byte 3	Byte 4	Byte 5
0x31	0x38	0x30	0x31	0x30	0x31

Byte 6	Byte 7	Byte 8	Byte 9	Byte 10	Byte 11
0x30	0x30	0x30	0x30	0x30	0x31

©SCALING\_FACTOR (0x00C0) :

Bit7~Bit0								
byte4~5	Reserved							
	Bit7	Bit6	Bit5	Bit4	Bit3	Bit2	Bit1	Bit0
byte3	Reserved				IIN Factor			
	Bit7	Bit6	Bit5	Bit4	Bit3	Bit2	Bit1	Bit0
byte2	Reserved				TEMPERATURE_1 Factor			
	Bit7	Bit6	Bit5	Bit4	Bit3	Bit2	Bit1	Bit0
byte1	FAN_SPEED Factor				VIN Factor			
	Bit7	Bit6	Bit5	Bit4	Bit3	Bit2	Bit1	Bit0
byte0	IOUT Factor				VOUT Factor			

byte0:

Bit 0:3 VOUT Factor : The factor of output voltage

0x0=Output voltage relevant commands not supported

0x4=0.001

0x5=0.01

0x6=0.1

0x7=1.0

0x8=10

0x9=100

Bit 4:7 IOUT Factor : The Factor of DC current  
 0x0=Output current relevant commands not supported  
 0x4=0.001  
 0x5=0.01  
 0x6=0.1  
 0x7=1.0  
 0x8=10  
 0x9=100

byte1:

Bit 0:3 VIN Factor : The Factor of AC input voltage  
 0x0=AC input relevant commands not supported  
 0x4=0.001  
 0x5=0.01  
 0x6=0.1  
 0x7=1.0  
 0x8=10  
 0x9=100

Bit 4:7 FAN\_SPEED Factor : The Factor of fan speed  
 0x0=Fan speed relevant commands not supported  
 0x4=0.001  
 0x5=0.01  
 0x6=0.1  
 0x7=1.0  
 0x8=10  
 0x9=100

byte2:

Bit 0:3 TEMPERATURE\_1 Factor : The Factor of internal ambient temperature  
 0x0=Internal ambient temperature relevant commands not supported  
 0x4=0.001  
 0x5=0.01  
 0x6=0.1  
 0x7=1.0  
 0x8=10  
 0x9=100

byte3:

Bit 0:3 IIN Factor : The Factor of AC input current  
 0x0=AC input current relevant commands not supported  
 0x4=0.001  
 0x5=0.01  
 0x6=0.1  
 0x7=1.0  
 0x8=10  
 0x9=100

©SYSTEM\_STATUS (0x00C1) :

	Bit7	Bit6	Bit5	Bit4	Bit3	Bit2	Bit1	Bit0
High byte	-	-	-	-	-	-	-	-
Low byte	-	EEPER	INITIA- LSTATE	ADL_ON	-	PFC_OK	DC_OK	M/S

Low byte

Bit 0: M/S : Parallel mode status  
 0 = Current device is Slave  
 1 = Current device is Master

Bit 1 DC\_OK : Secondary DD output voltage status  
 0 = Secondary DD output voltage status TOO LOW  
 1 = Secondary DD output voltage status NORMAL

Bit 2: PFC\_OK : Primary PFC status  
 0 = Primary PFC OFF or abnormal  
 1 = Primary PFC ON normally

Bit 4 ADL\_ON : Active dummy load control status  
 0 = Active dummy load off/function not supported  
 1 = Active dummy load on

Bit 5 INITIAL\_STATE : Device initialized status  
 0 = NOT in initialization status  
 1 = In initialization status

Bit 6 EEPER : EEPROM data access error  
 0 = EEPROM data access normal  
 1 = EEPROM data access error

Note: Unsupported settings displays with "0"

©SYSTEM\_CONFIG (0x00C2) :

High byte	Bit7	Bit6	Bit5	Bit4	Bit3	Bit2	Bit1	Bit0
Definition	-	-	-	-	-	EEP_OFF	EEP_CONFIG	
Low byte	Bit7	Bit6	Bit5	Bit4	Bit3	Bit2	Bit1	Bit0
Definition	-	-	-	-	-	OPERATION_INIT	CAN_CTRL	

Low byte:

Bit 0 CAN\_CTRL : CANBus communication control status

0 = The output voltage/current defined by control over SVR/PV/PC (factory default)

1 = The output voltage, current, ON/OFF control defined by control over CANBus (VOUT\_SET, IOUT\_SET, OPERATION)

Bit 1:2 OPERATION\_INIT : Pre-set value of power on operation command

0b00 = Power OFF, pre-set 0x00(OFF)

0b01 = Power ON, pre-set 0x01(ON) (factory default)

0b10 = Pre-set is previous set value

0b11 = Not used, reserved

High Byte:

Bit 0:1 EEP\_CONFIG: EEPROM Configuration

00: Immediate. Changes to parameters are written to EEPROM immediately (factory default)

01: 1 minute delay. Write changes to EEPROM if all parameters remain unchanged for 1 minute

10: 10 minute delay. Write changes to EEPROM if all parameters remain unchanged for 10 minutes

11: Reserved

Bit 2 EEP\_OFF: EEPROM storage function ON/OFF

0: Enable. Parameters to be saved into EEPROM (factory default)

1: Disable. Parameters NOT to be saved into EEPROM

Note: Unsupported settings display with "0"

### 6.2.3 Communication Examples

The following provides examples of command sending and data reading for the CANbus protocol.

#### 6.2.3.1 Sending command

The master adjusts output voltage of the unit with address "01" to 30V.

CAN ID	DLC (data length)	Command code	Parameters
0x000C0101	0x4	0x2000	0xB80B

Command code: 0x0020 (VOUT\_SET) → 0x20(Lo) + 0x00(Hi)

Parameters: 30V → 3000 → 0x0BB8 → 0xB8(Lo) + 0x0B(Hi)

NOTE: Conversion factor for VOUT\_SET is 0.01, so  $\frac{30V}{F=0.01} = 3000$

#### 6.2.3.2 Reading data or status

The master reads operation setting from the unit with address "00".

CAN ID	DLC (data length)	Command code
0x000C0100	0x2	0x0000

The unit with address "00" returns data below:

CAN ID	DLC (data length)	Command code	Parameters
0x000C0000	0x3	0x0000	0x01

Parameters: 0x01 ON, meaning that the unit with address "00" is operating.

## 6.3 Modbus Communication Interface

The device supports Modbus RTU with the master-slave principle. Users are able to read and write parameters of the device through the protocol, including remote ON/OFF, output voltage/current setting, etc. During data transfer, please follow the principle of first sending the Hi byte and then the Lo byte except Error Check (CRC16 checksum).

Physical Layer setting as below

Control	Setting
Baud Rate	115200
Data Bits	8
Stop Bit	1
Parity	None
Flow Control	None

#### 6.3.1 Communication Timing

Min. request period (Controller to PSU/CHG): 50mSec ◦

Max. response time (PSU/CHG to Controller): 12.5mSec ◦

Min. packet margin time (Controller to PSU/CHG): 12.5mSec ◦

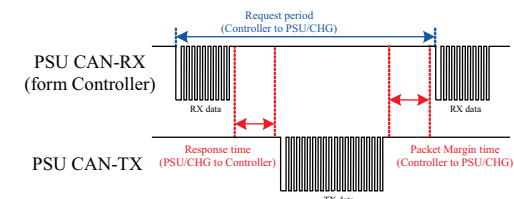

### 6.3.2 Modbus Frame Encapsulation

Modbus RTU consists of Additional Address, Function Code, Data and Error Check.

Additional Address	Function Code	Data	Error Check
1 byte	1 byte	N bytes	2 bytes

Additional address (1byte) : defines PSU/Charger slave ID.

Function code (1byte) : The function code is used to tell the slave what kind of action to perform.

Data (N bytes):For data exchange, contents and data length are dependent on different function codes.

Error Check (2bytes) : utilizes CRC-16.

### 6.3.3 Additional Address Definition

Additional address is the slave ID of the device. Each SHP-10K unit should have their unique and own device address to communicate over the bus.

Slave ID	Description
0x8X	X mean device address (defined by DIP-SW81)
0x00	Broadcast

Note: 1.X means the address of SHP-10K ( which can be assigned by the DIP-SW81, range from 0 ~ 7)



Device No.	DIP switch position		
	1	2	3
0	ON	ON	ON
1	OFF	ON	ON
2	ON	OFF	ON
3	OFF	OFF	ON
4	ON	ON	OFF
5	OFF	ON	OFF
6	ON	OFF	OFF
7	OFF	OFF	OFF

Table 6-5

2. Broadcast is only for command write and not for read

### 6.3.4 Function Code Description

The main purpose of the function codes is to tell the slave what kind of action to perform. For example: Function code 03 will query the slave to read holding registers and respond with the master their contents.

Code	Function Code
0x03	Read Holding Register
0x04	Read Input Register
0x06	Preset Single Register

### 6.3.5 Data Field and Command Lists

Data field provides additional information by the slave to complete the action specified by the function code(FC) in a request. The data field typically includes register addresses, count values, and written data. There are several forms according to the function codes.

FC = 03/04

Starting Address	Quantity of (Input) Registers
2 Bytes	2 Bytes

FC = 06

Register Address	Register Value
2 Bytes	2 Bytes

Table 6-6

Register address	Command Name	Function code	# of data Bytes	Description
0x0000	OPERATION	0x03 · 0x06	1	Remote ON/OFF control ON: 0x0001 OFF: 0x0000
0x0020	VOUT_SET*	0x03 · 0x06	2	Output voltage set (format: value, F=0.01)
0x0030	IOUT_SET*	0x03 · 0x06	2	Output current set (format: value, F=0.01)
0x0040	FAULT_STATUS	0x03	2	Abnormal status
0x0050	READ_VIN_RS	0x04	2	V <sub>RS</sub> input voltage read value (format: value, F=0.1)
0x0051	READ_VIN_ST	0x04	2	V <sub>ST</sub> input voltage read value (format: value, F=0.1)
0x0052	READ_VIN_TR	0x04	2	V <sub>TR</sub> input voltage read value (format: value, F=0.1)



Register address	Command Name	Function code	# of data Bytes	Description
0x0053	READ_IIN_R	0x04	2	R phase input current read value (format: value, F=0.1)
0x0054	READ_IIN_S	0x04	2	S phase input current read value (format: value, F=0.1)
0x0055	READ_IIN_T	0x04	2	T phase input current read value (format: value, F=0.1)
0x0060	READ_VOUT	0x04	2	Output voltage read value (format: value, F=0.01)
0x0061	READ_IOUT	0x04	2	Output current read value (format: value, F=0.01)
0x0062	READ TEMPERATURE_1	0x04	2	Internal ambient temperature (format: value, F=0.1)
0x0070	READ_FAN_SPEED_1	R	2	Fan speed 1 reading value (format: value, F=1)
0x0071	READ_FAN_SPEED_2	R	2	Fan speed 2 reading value (format: value, F=1)
0x0080	MFR_ID_B0B5	0x03	6	Manufacture's name
0x0083	MFR_ID_B6B11	0x03	6	Manufacture's name
0x0086	MFR_MODEL_B0B5	0x03	6	Manufacture model name
0x0089	MFR_MODEL_B6B11	0x03	6	Manufacture model name
0x008C	MFR_REVISION_B0B5	0x03	6	Firmware version
0x008F	MFR_LOCATION_B0B2	0x03	4	Manufacture place
0x0091	MFR_DATE_B0B5	0x03	6	Manufacture date
0x0094	MFR_SERIAL_B0B5	0x03	6	Manufacture serial number
0x0097	MFR_SERIAL_B6B11	0x03	1	Manufacture serial number
0x00C0	SCALING_FACTOR	0x03	2	Scaling ratio
0x00C3	SYSTEM_STATUS	0x03	2	System status
0x00C4	SYSTEM_CONFIG	0x03 · 0x06	2	System configuration

Note: Setting commands with \* at the end support the EEP\_OFF and EEP\_CONFIG functions. For detailed information on how to enable them, please refer to SYSTEM\_CONFIG (0x00C4).

### Data conversion :

The conversion of setting and reading values is defined as following:  
 Actual value = Communication reading value x Factor (F value). Among them, Factor needs to refer to the definition of SCALING\_FACTOR in each model list.  
 EX: VDC\_real (actual DC voltage) = READ\_VOUT x Factor. If the Factor of READ\_VOUT of a certain model is 0.01, the communication reading value is 0x0960 (hexadecimal)→2400 (decimal), then VDC\_real = 2400 x 0.01 = 24.00V.

### ◎FAULT\_STATUS (0x0040) :

	Bit7	Bit6	Bit5	Bit4	Bit3	Bit2	Bit1	Bit0
High byte	-	-	-	-	-	-	-	-
Low byte	HI_TEMP	OP_OFF	AC_FAIL	SHORT	OLP	OVP	OTP	FAN_FAIL

#### Low byte

Bit 0 FAN\_FAIL : Fan locked flag

0 working normally = Fan

1 = Fan locked

Bit 1 OTP : Over temperature protection

0 = Internal temperature normal

1 = Internal temperature abnormal

Bit 2 OVP : Output over-voltage protection

0 = Output voltage normal

1 = Output over voltage protected

Bit 3 OLP : Output over current protection

0 = Output current normal

1 = Output over-current protected

Bit 4 SHORT : Short circuit protection

0 = Shorted circuit do not exist

1 = Shorted circuit protected

Bit 5 AC\_FAIL : AC abnormal flag

0 = AC range normal

1 = AC range abnormal

Bit 6 OP\_OFF : DC status

0 = DC turned on

1 = DC turned off

Bit 7 HI\_TEMP : Internal high temperature protection

0 = Internal temperature normal

1 = Internal temperature abnormal

Note: Unsupported settings displays with "0"

©MFR\_ID\_B0B5 (0x0080 - 0x0082) is the first 6 codes of the manufacturer's name (ASCII); MFR\_ID\_B6B11(0x0083 - 0x0085) is the last 6 codes of the manufacturer's name (ASCII)

EX: manufacturer's name is MEANWELL → MFR\_ID\_B0B5 is MEANWE ;  
MFR\_ID\_B6B11 is LL

MFR_ID_B0B5					
Byte 0	Byte 1	Byte 2	Byte 3	Byte 4	Byte 5
0x4D	0x45	0x41	0x4E	0x57	0x45

MFR_ID_B6B11					
Byte 0	Byte 1	Byte 2	Byte 3	Byte 4	Byte 5
0x4C	0x4C	0x20	0x20	0x20	0x20

©MFR\_MODEL\_B0B5 (0x0086 - 0x0088) is the first 6 codes of the manufacturer's model name (ASCII); MFR\_MODEL\_B6B11(0x0089 - 0x008B) is the last 6 codes of the manufacturer's model name (ASCII)

EX: Model name is SHP-10K-55 → MFR\_MODEL\_B0B5 is SHP-10 ;  
MFR\_MODEL\_B6B11 is K-55

MFR_MODEL_B0B5					
Byte 0	Byte 1	Byte 2	Byte 3	Byte 4	Byte 5
0x50	0x48	0x50	0x2D	0x33	0x35

MFR_MODEL_B6B11					
Byte 6	Byte 7	Byte 8	Byte 9	Byte 10	Byte 11
0x30	0x30	0x2D	0x32	0x34	0x20

©MFR\_REVISION\_B0B5 (0x008C - 0x008E) is the firmware revision. A range of 0x00 hexadecimal (R00.0)~0xFE (R25.4) represents the firmware version of an MCU; 0xFF represents no MCU existed

EX: The supply has two MCUs, the firmware version of the MCU number 1 is version R25.4 (0xFE), the MCU number 2 is version R10.5 (0x69)

Byte 0	Byte 1	Byte 2	Byte 3	Byte 4	Byte 5
0xFE	0x69	0xFF	0xFF	0xFF	0xFF

©MFR\_DATE\_B0B5 (0x0091 - 0x0093) is manufacture date (ASCII)  
EX: MFR\_DATE\_B0B5 is 180101, meaning 2018/01/01

Byte 0	Byte 1	Byte 2	Byte 3	Byte 4	Byte 5
0x31	0x38	0x30	0x31	0x30	0x31

©MFR\_SERIAL\_B0B5 (0x0094 - 0x0096) and MFR\_SERIAL\_B6B11 (0x0097 - 0x0099) are defined as manufacture date and manufacture serial number (ASCII)

EX: The first unit manufactured on 2018/01/01 → MFR\_SERIAL\_B0B5: 180101 ; MFR\_SERIAL\_B6B11: 000001

Byte 0	Byte 1	Byte 2	Byte 3	Byte 4	Byte 5
0x31	0x38	0x30	0x31	0x30	0x31

Byte 6	Byte 7	Byte 8	Byte 9	Byte 10	Byte 11
0x30	0x30	0x30	0x30	0x30	0x31

©SCALING\_FACTOR (0x00C0) :

Bit7~Bit0								
byte4~5	Reserved							
	Bit7	Bit6	Bit5	Bit4	Bit3	Bit2	Bit1	Bit0
byte3	Reserved				IIN Factor			
	Bit7	Bit6	Bit5	Bit4	Bit3	Bit2	Bit1	Bit0
byte2	Reserved				TEMPERATURE_1 Factor			
	Bit7	Bit6	Bit5	Bit4	Bit3	Bit2	Bit1	Bit0
byte1	FAN_SPEED Factor				VIN Factor			
	Bit7	Bit6	Bit5	Bit4	Bit3	Bit2	Bit1	Bit0
byte0	IOUT Factor				VOUT Factor			

byte0:

Bit 0:3 VOUT Factor : The factor of output voltage

0x0=Output voltage relevant commands not supported

0x4=0.001

0x5=0.01

0x6=0.1

0x7=1.0

0x8=10

0x9=100

0xA~0xF= Reserved

Bit 4:7 IOUT Factor : The Factor of DC current

0x0=Output current relevant commands not supported

0x4=0.001

0x5=0.01

0x6=0.1

0x7=1.0

0x8=10

0x9=100

0xA~0xF= Reserved

byte1:

Bit 0:3 VIN Factor : The Factor of AC input voltage

0x0=AC input relevant commands not supported

0x4=0.001

0x5=0.01

0x6=0.1

0x7=1.0

0x8=10

0x9=100

0xA~0xF= Reserved

Bit 4:7 FAN\_SPEED Factor : The Factor of fan speed

0x0=Fan speed relevant commands not supported

0x4=0.001

0x5=0.01

0x6=0.1

0x7=1.0

0x8=10

0x9=100

0xA~0xF= Reserved

byte2:

Bit 0:3 TEMPERATURE\_1 Factor : The Factor of internal ambient temperature

0x0=internal ambient temperature relevant commands not supported

0x4=0.001

0x5=0.01

0x6=0.1

0x7=1.0

0x8=10

0x9=100

0xA~0xF= Reserved

©SYSTEM\_STATUS (0x00C3) :

	Bit7	Bit6	Bit5	Bit4	Bit3	Bit2	Bit1	Bit0
High byte	-	-	-	-	-	-	-	-
Low byte	-	EEPER	INITIA-LSTATE	ADL_ON	-	PFC_OK	DC_OK	M/S

Low byte

Bit 0: M/S : parallel mode status

0 = Current device is Slave

1 = Current device is Master

Bit 1 DC\_OK : Secondary DD output voltage status

0 = Secondary DD output voltage status TOO LOW

1 = Secondary DD output voltage status NORMAL

Bit 2: PFC\_OK : Primary PFC status

0 = Primary PFC OFF or abnormal

1 = Primary PFC ON normally

Bit 4 ADL\_ON : Active dummy load control status

0 = Active dummy load off/function not supported

1 = Active dummy load on

Bit 5 INITIAL\_STATE : Device initialized status

0 = NOT in initialization status

1 = In initialization status

Bit 6 EEPER : EEPROM data access error

0 = EEPROM data access normal

1 = EEPROM data access error

Note: Unsupported settings displays with "0"

SYSTEM\_CONFIG (0x00C4) :

	Bit7	Bit6	Bit5	Bit4	Bit3	Bit2	Bit1	Bit0
High byte	-	-	-	-	-	EEP_OFF	EEP_CONFIG	
Low byte	-	-	-	-	-	OPERATION_INI		MOD_CTRL

Low byte:

Bit 0

MOD\_CTRL : Modbus communication control status

0 = The output voltage/current defined by control over SVR/PV/PC (factory default)

1 = The output voltage, current, ON/OFF control defined by control over Modbus (VOUT\_SET, IOU\_T\_SET, OPERATION)

OPERATION\_INIT : Pre-set value of power on operation command

0b00 = Power OFF, pre-set 0x00(OFF)

0b01 = Power ON, pre-set 0x01(ON) (factory default)

0b10 = Pre-set is previous set value

0b11 = not used, reserved

High Byte:

Bit 0:1 EEP\_CONFIG: EEPROM Configuration

00: Immediate. Changes to parameters are written to EEPROM immediately (factory default)

01: 1 minute delay. Write changes to EEPROM if all parameters remain unchanged for 1 minute

10: 10 minute delay. Write changes to EEPROM if all parameters remain unchanged for 10 minutes

11: Reserved

Bit 2 EEP\_OFF: EEPROM storage function ON/OFF

0: Enable. Parameters to be saved into EEPROM (factory default)

1: Disable. Parameters NOT to be saved into EEPROM

Note: Unsupported settings displays with "0"

6.3.7 Communication Examples

The following provides examples of request and response for each function code of the Modbus RTU.

6.3.7.1 Read Holding Registers (FC=03)

The request message specifies the starting register and quantity of registers to be read.

For example: the master requests the content of analog output holding registers 0x008C-0x008E (MFR\_REVISION\_B0B5) from slave 0.

Request:

0x80	0x03	0x008C	0x0003	0xDA31
------	------	--------	--------	--------

0x80: Slave ID 0

0x03: Function code 3 (Read Analog Output Holding R Registers)

0x008C: The Data Address of the first register requested.

0x0003: The total number of registers requested ( Read 3 registers from 0x008C to 0x008E)

0xDA31: CRC16 Error Check. Please be aware that CRC sending the Lo byte first.

Response:

0x80	0x03	0x06	0xAFFFFFFFFF	0x7DEC
------	------	------	--------------	--------

0x80: Slave ID 0

0x03: Function code 3 (Read Analog Output Holding R Registers)

0x06: The number of data bytes to follow (6 bytes)

0x0A FF FF FF FF FF: means that the firmware version of the MCU number1 is R01.0.

0x7DEC: CRC16 Error Check. Please be aware that CRC sending the Lo byte first.

### 6.3.7.2 Read Input Register (FC=04)

The request message specifies the starting register and quantity of registers to be read. For example: The master requests the content of analog input register 0x0060 (READ\_VOUT) from slave 0

Request:

0x80	0x04	0x0060	0x0001	0x2FC5
------	------	--------	--------	--------

0x80: Slave ID 0

0x04: Function code 4 (Read Analog Input Registers)

0x0060: The Data Address of the first register requested

0x0001: the total number of registers requested ( read only 1 registers from 0x0060)

0x2FC5: CRC16 Error Check. Please be aware that CRC sending the Lo byte first.

Response:

0x80	0x04	02	0x157C	0x0D03
------	------	----	--------	--------

0x80: Slave ID 0

0x04: Function code 4 (Read Analog Input Register)

0x02: The number of data bytes to follow (2 bytes)

0x157C: The contents of register: 0x0060(READ\_VOUT).  $157C_{16} = 5500_{10} = 55.00V$

0x0D03: CRC16 Error Check. Please be aware that CRC sending the Lo byte

### 6.3.7.3 Write Single Register (FC=06)

The request message specifies the register reference to be written.

For example: the master writes PSU ON to analog output holding register of 0x0000 (OPERATION) for slave 0

Request:

0x80	0x06	0x0000	0x0001	0x561B
------	------	--------	--------	--------

0x80: Slave ID 0

0x06: Function code 6 (Preset Single Register)

0x0000: The Data Address of the register

0x0001: The value to write

0x561B: CRC16 Error Check. Please be aware that CRC sending the Lo byte first.

Response:

The normal response is an echo of the query, returned after the register contents have been written.

## 6.4 Value range and tolerance

(1)Display parameters

	Model	Display value range	Tolerance
READ_VIN	ALL	340~530V	±10V
READ_IIN	ALL	0~18.8A	±0.3V
READ_VOUT	55V	0~57.6V	±0.55V
	115V	0~138V	±1.15V
	230V	0~260V	±2.3V
	380V	0~400V	±3.8V
READ_IOUT (Note. i)	55V	0~165A	±1.5A
	115V	0~95.7A	±0.87A
	230V	0~50.8A	±0.46A
	380V	0~33A	±0.3A
READ_TEMPERATURE_1	ALL	-40~110°C	±5°C

## (2)Control parameters

	Model	Display value range	Tolerance	Default
OPERATION	ALL	PM: 00h(OFF)/01h(ON) CAN/MOD: 00h(OFF)/01h(ON)	N/A	ON
VOUT_TRIM (PMBus only)	55V	-31~2.6V	±0.55V	0V
	115V	-57.5~23V	±1.15V	0V
	230V	-122~30V	±2.3V	0V
	380V	-213~20V	±3.8V	0V
VOUT_SET (CAN bus and Modbus only)	55V	24~57.6V	±0.55V	55V
	115V	57.5~138V	±1.15V	115V
	230V	108~260V	±2.3V	230V
	380V	167~400V	±3.8V	380V
IOUT_OC_FAULT_LIMIT/ IOUT_SET	55V	30~153.7A	±1.5A	153.7A
	115V	17.4~89.1A	±0.87A	89.1A
	230V	9.2~47.4A	±0.46A	47.4A
	380V	6~30.7A	±0.3A	30.7A
SYSTEM_CONFIG	ALL	N/A	N/A	02h

Note:

i. READ\_IOUT will display ZERO amp when output current is less than values in the table below.

Model	Minimum readable
55V	1.5A±1.5A
115V	0.87A±0.87A
230V	0.46A±0.46A
380V	0.3A±0.3A

ii. Owing to the limited write cycles of the EEPROM, it is advisable to consider using the SYSTEM\_CONFIG (PM: BEh; CAN: 0x00C2; MOD: 0x00C4) command to select an appropriate EEPROM writing logic, especially if communication settings are frequently altered.

## 7. Protections and Trouble Shooting

### 7.1 Protections

#### 7.1.1 Over Temperature Protection (OTP) and T Alarm

Built-in thermal detection circuit, once the internal temperature exceeds a threshold value, the supply will shut down automatically. Please switch off the supply, remove all possible causes and then leave the supply cooling down to a normal working temperature (approximate 10 minutes – 1 hour) before repower on again

T-ALARM to GND-AUX TTL	Condition
LOW(3.5~5.5V)	Normal Temp.
HIGH(-0.5~0.5V)	Abnormal temp.

#### 7.1.2 AC Fail

When AC voltage is too low, SHP-10K will enter protection mode to prevent damaging itself. The supply will restore automatically when AC voltage is back to a normal range.

AC-OK to GND-AUX TTL	Condition
HIGH(3.5~5.5V)	AC voltage normal ( $\geq 335 \pm 1.5\% \text{Vac}$ )
LOW(-0.5~0.5V)	AC voltage too low ( $\leq 320 \pm 1.5\% \text{Vac}$ )

#### 7.1.3 FAN FAIL

When the fan is locked or damaged, SHP-10K will enter a protection mode to shut down its output. Repower on to restore after fan-fail condition is resolved.

FAN FAIL to GND-AUX TTL	Condition
HIGH(3.5~5.5V)	Fan abnormal
LOW(-0.5~0.5V)	Fan working normal

#### 7.1.4 Short Circuit Protection

When there is short circuit at output of SHP-10K, the supply will enter protection mode and shut down. Repower on to restore after short-circuit condition is resolved.

### 7.1.5 Over Load Protection

When the load current exceeds  $110\% \pm 5\%$  of the rated current, protection mode will be triggered. Repower on to restore after overcurrent condition is resolved.

### 7.1.6 Over Voltage Protection

When the output voltage is too high, the over-voltage protection circuit will be triggered. Repower on to restore after over-voltage condition is resolved.

## 7.2 Trouble Shooting

Failure Stage	Possible Cause	Suggested Solution
No output voltage	Remote OFF	Make sure Remote ON-OFF is connected to 5V-AUX

**If you are unable to clarify the problem you are facing, please contact MEAN WELL or any of our distributors for repair service.**

## 8.Warranty

This product provides 5 years warranty under normal usage. Do not replace parts or any form of modification to the product in order to keep the warranty effectively.

※ **MEAN WELL possesses the right to adjust the content of this manual. Please refer to the latest version of manual on our website.**  
<https://www.meanwell.com>



明緯企業股份有限公司

MEAN WELL ENTERPRISES CO., LTD.

248 新北市五股區五權三路28號

No.28, Wuquan 3rd Rd., Wugu Dist., New Taipei City 248, Taiwan

Tel:886-2-2299-6100 Fax:886-2-2299-6200

<http://www.meanwell.com> E-mail:[info@meanwell.com](mailto:info@meanwell.com)